

Table of content of printouts:

- ✓ Introduction
- ✓ Materials and Properties of Polymer Matrix Composites
- ✓ Mechanics of a Lamina
- ✓ Laminate Theory
- ✓ Ply by Ply Failure Analysis
- FRP Strengthening of Metallic Structures
- ✓ Externally Bonded FRP Reinforcement for RC Structures: Overview
- ✓ Flexural Strengthening
- ✓ Strengthening in Shear
- **Column Confinement**
- FRP Strengthening of Timber Structures
- Design of Flexural Post-Strengthening of RC: Swiss Code 166 and Other Codes/Guidelines
- ✓ Design of FRP Profiles and all FRP Structures
- An Introduction to FRP Reinforced Concrete
- Structural Monitoring with Wireless Sensor Networks
- Composite Manufacturing
- Testing Methods



Ground storeys of reinforced concrete buildings are left open to facilitate parking

Earthquake oscillations

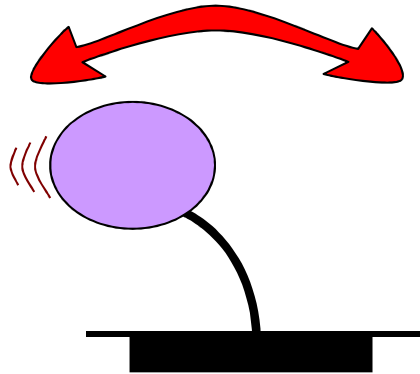

Inverted Pendulum

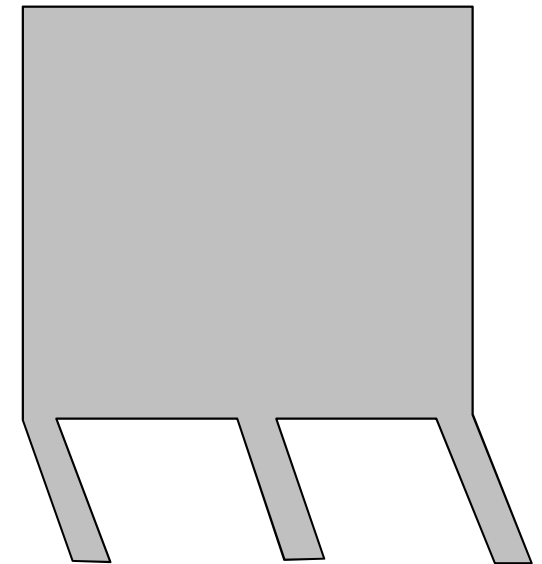
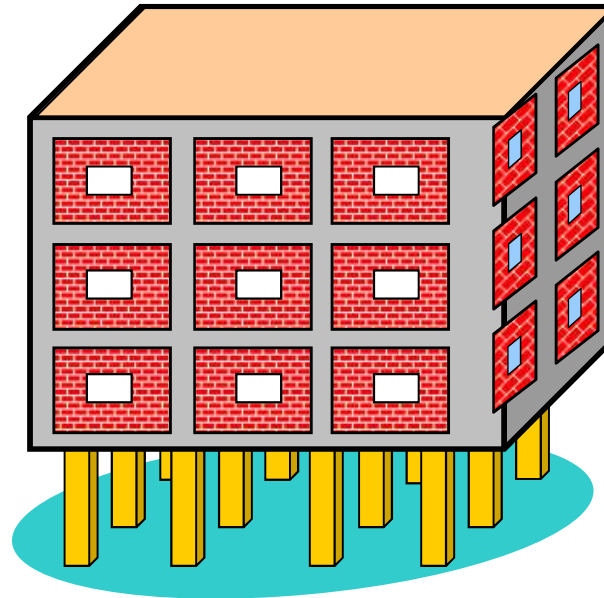

Soft ground storey:
*Large displacement between
foundation and first floor*

Stiff upper storeys:
*Small displacement between adjacent
floors*

***Ground storey columns
severely stressed***



1971 San Fernando Earthquake



2001 Bhuj Earthquake

Consequences of open ground storeys in RC frame buildings – *severe damage to ground storey columns and building collapses.*

sloping ground and buildings with a mezzanine floor

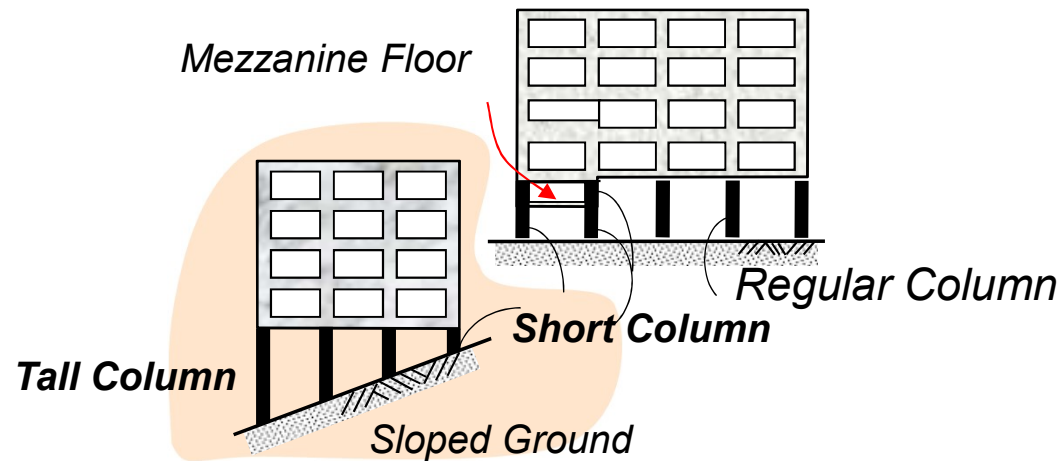

Buildings with short columns – *two explicit examples of common occurrences.*

Tall Column: *Attracts smaller horizontal force*

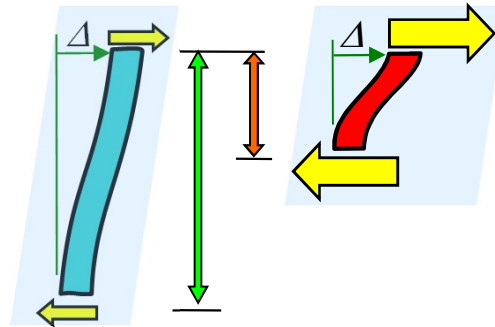

Short Column: *Attracts larger horizontal force*

Short columns are stiffer and attract larger forces during earthquakes – *this must be accounted for in design.*

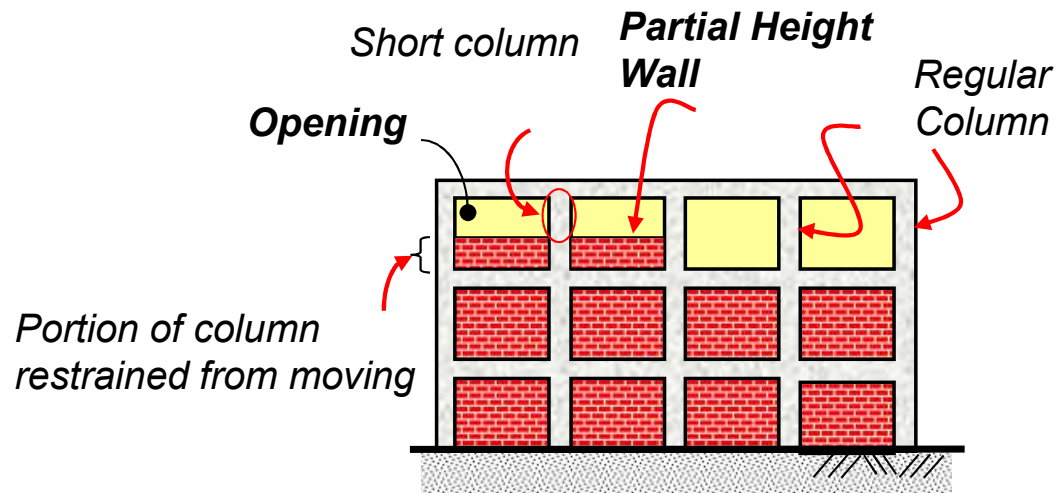

Short columns effect in RC buildings when partial height walls adjoin columns – the effect is implicit here because infill walls are often treated as non-structural elements.

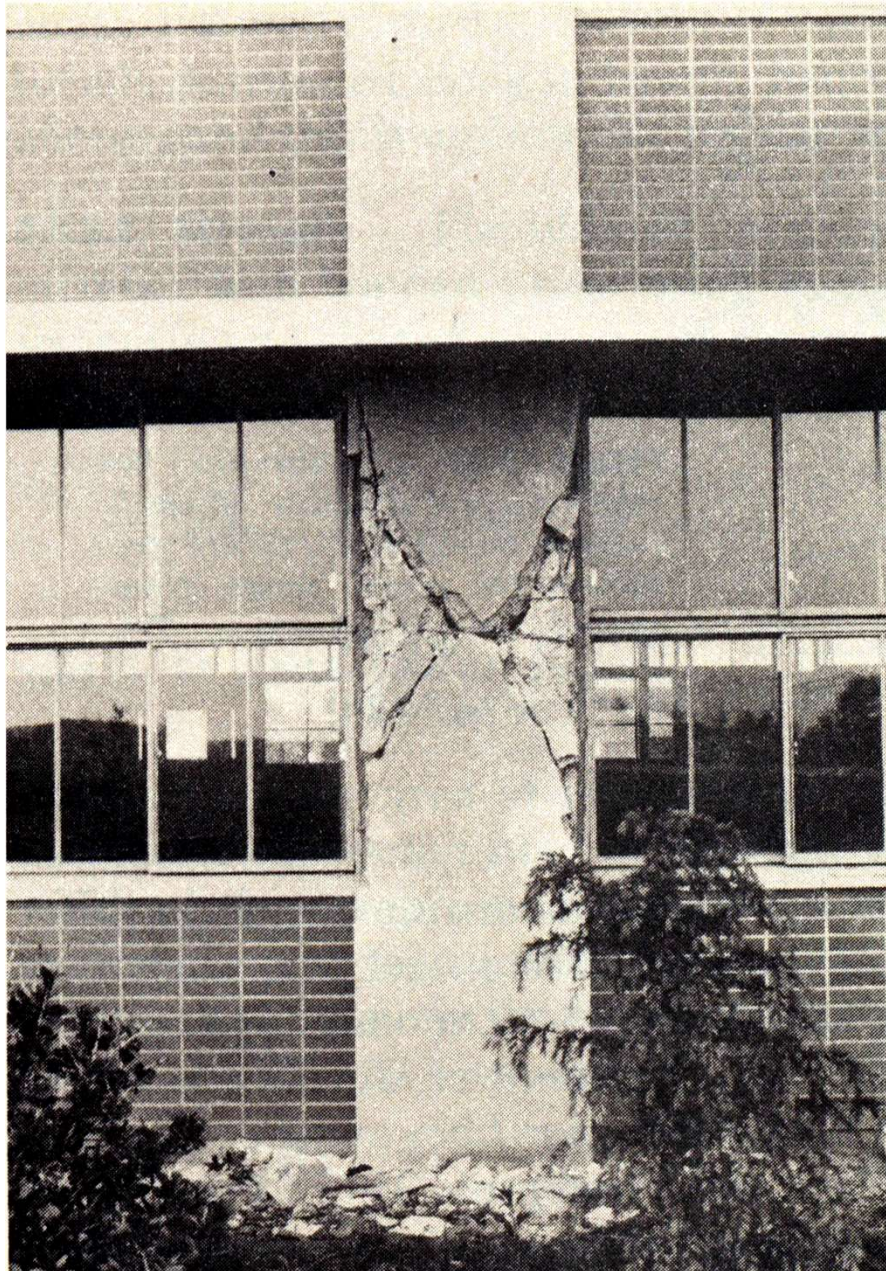

Short column



Bild 34: "Short Column"

Other reasons for column failure due to an earthquake:

- Not sufficient lateral reinforcement
- Not sufficient concrete strength
- Not sufficient ductility



Buckling of lateral reinforcement due to earthquake



Column Confinement

Book Composite for Construction, L. C. Bank, Chapter 11

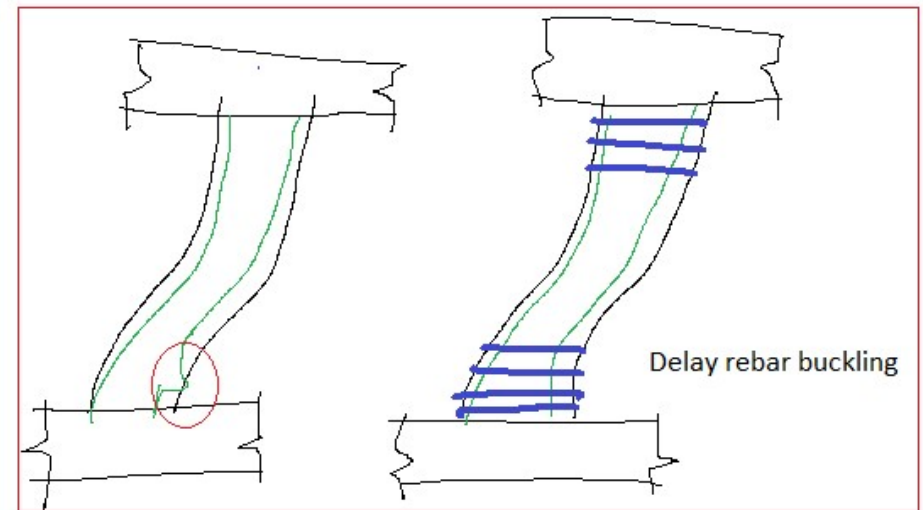
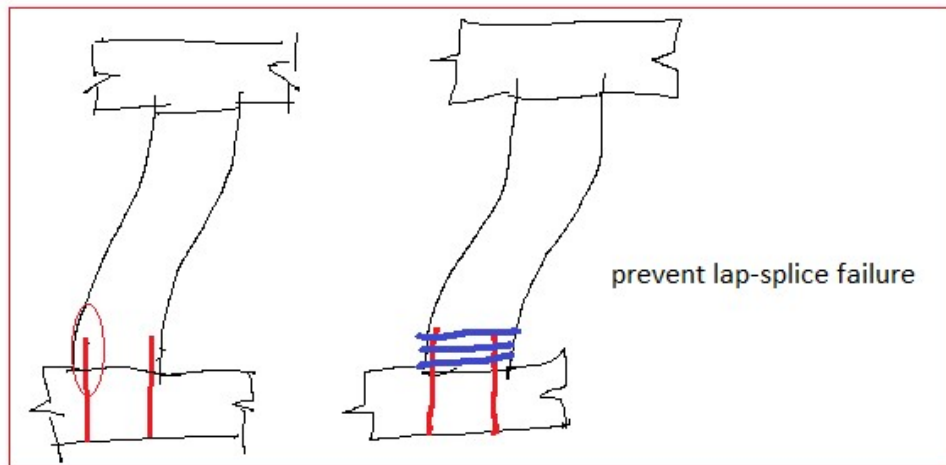
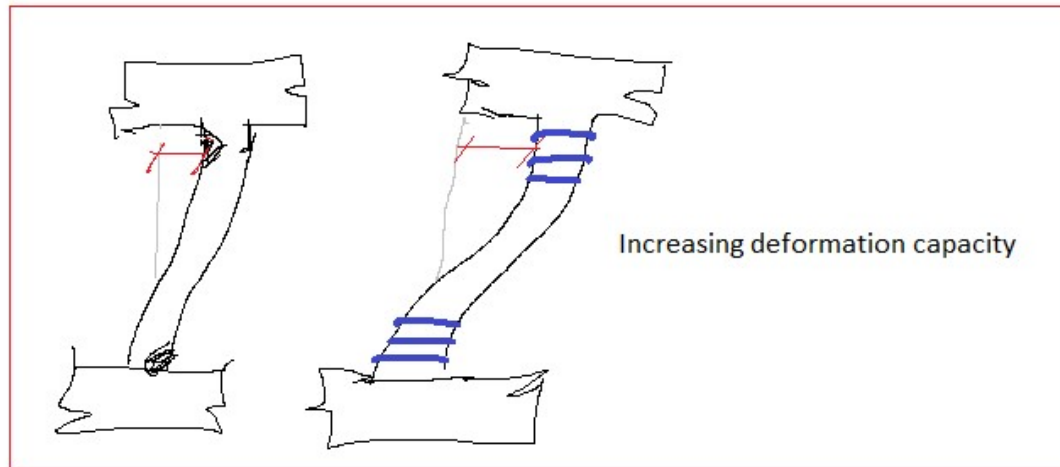
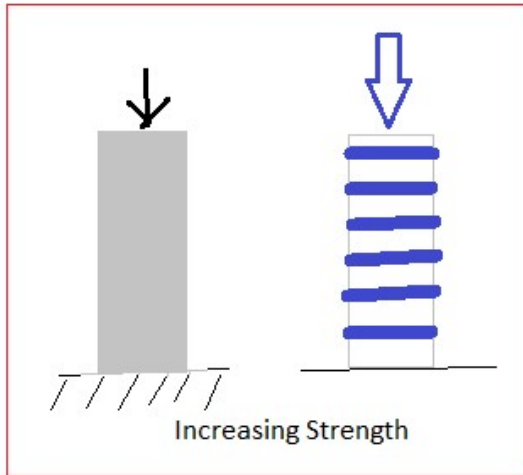

Column Confinement : Increasing strength

- FRP sheets can be wrapped around concrete columns to **increase strength**
- How it works:

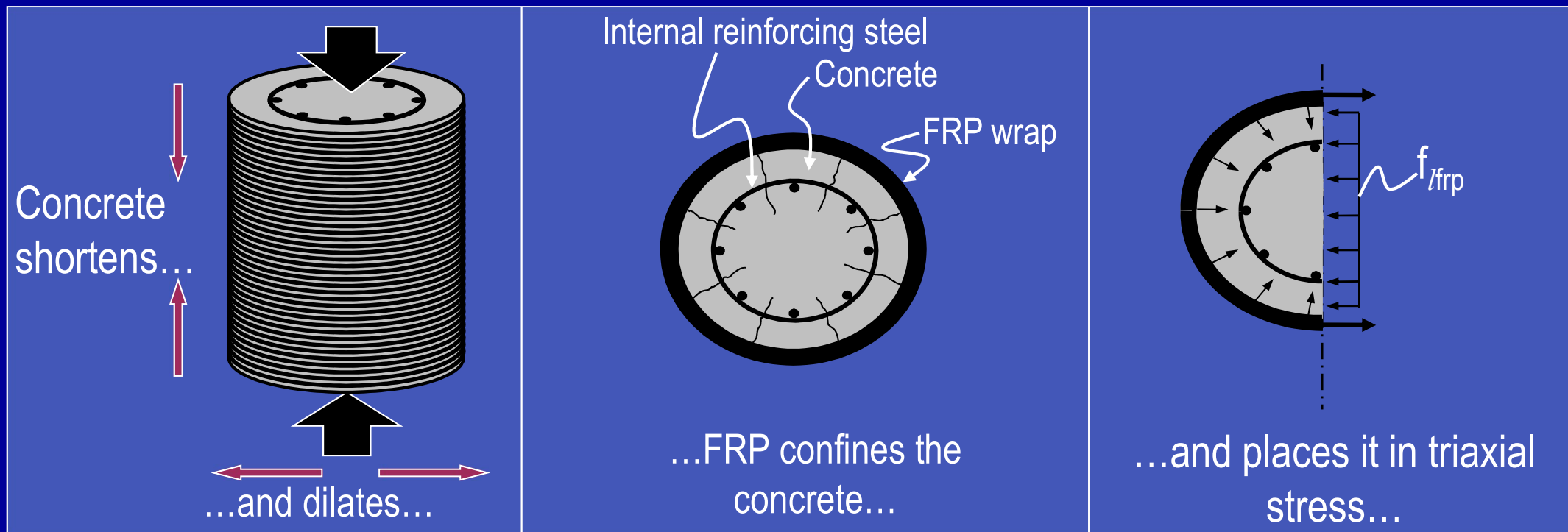

Axially loaded fiber reinforced polymer confined concrete

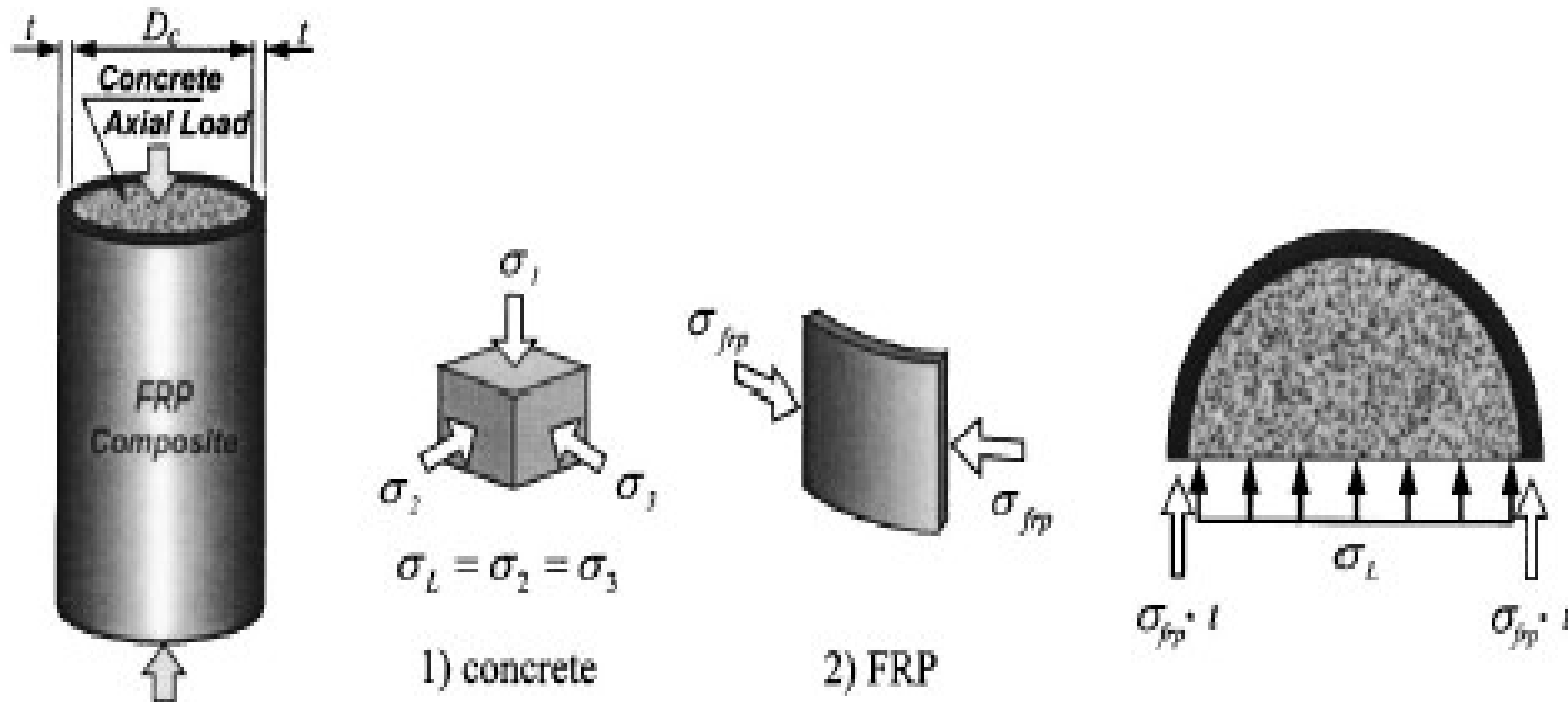

Triaxial state of stress in FRP jackets

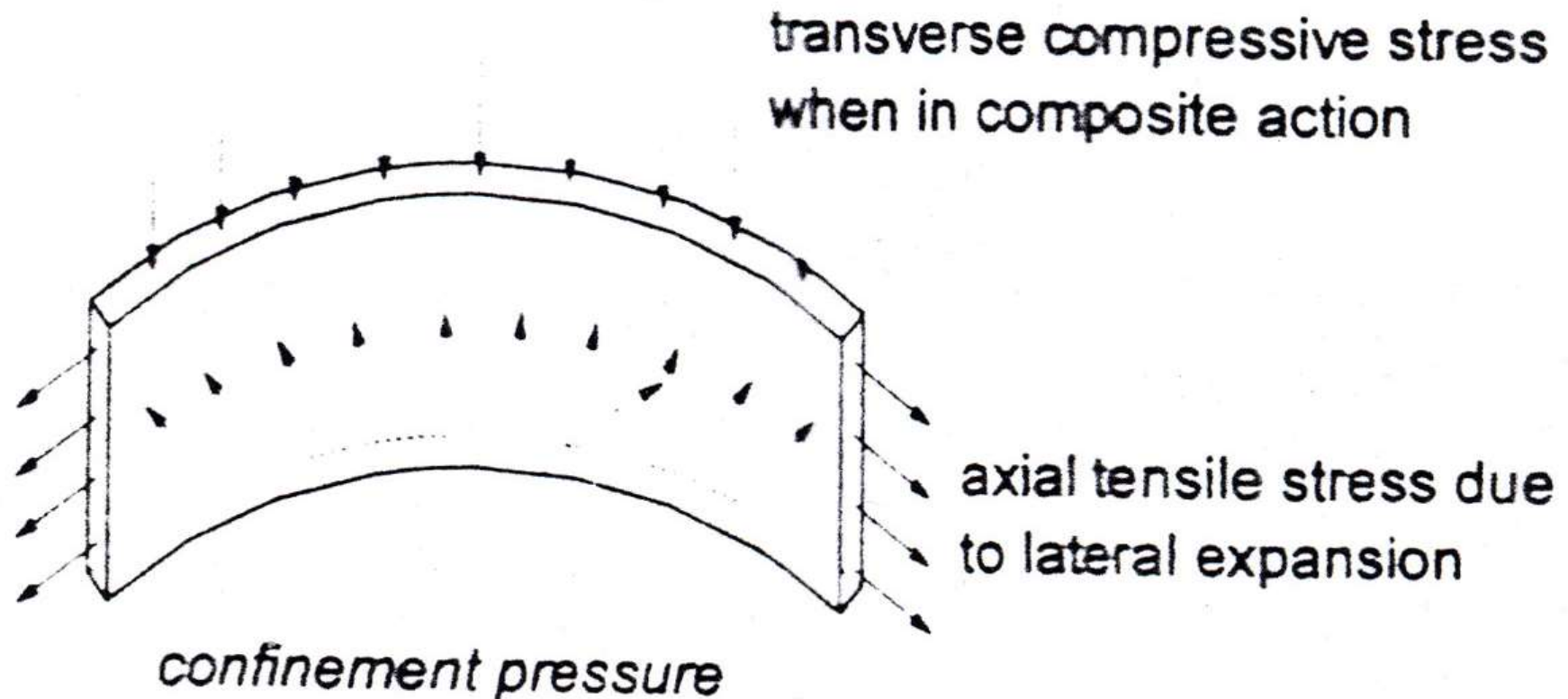

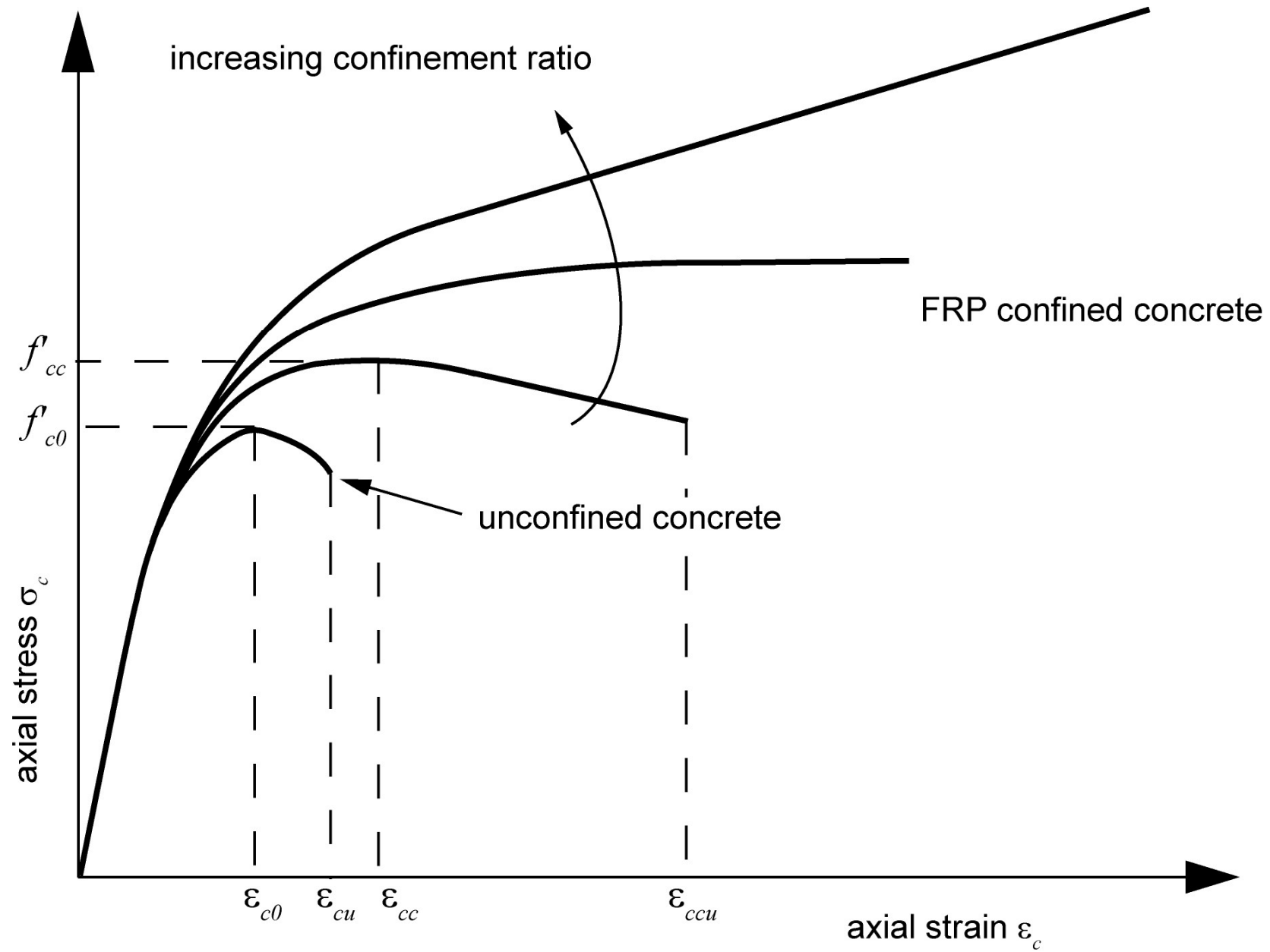

Application of FRP

FRP, as opposed to steel that applies a constant confinement pressure after yield has an elastic behaviour up to failure and therefore exerts its confining action on concrete specimens under axial load in a different way with respect to steel.

The amount of this action depends on the lateral dilation of concrete, which in turn is affected by the confining pressure.

FRP jacket effective ultimate circumferential strain ϵ_{ju}

Experimental evidence shows that:

$$\epsilon_{ju} < \epsilon_{fu}$$

Possible reasons:

- The triaxial state of stress of the wrapping reinforcement.
- The quality of execution.
- The curved shape of the wrapping reinforcement.
- Size effects when applying multiple layers.

Lateral FRP confining pressure

For the case of **concrete cylinders** confined with FRP reinforcement, with fibers circumferentially aligned and covering the total concrete surface, the lateral confining pressure can be evaluated:

$$\sigma_l = \frac{1}{2} \rho_j \sigma_j = \frac{1}{2} \rho_j E_j \varepsilon_j \quad \rho_j = \frac{4t_j}{d_j}$$

With:

ρ_j : volumetric ratio of FRP jacket.

σ_j : stress in FRP jacket.

E_j : FRP E-modulus in fiber direction.

ε_j : circumferential strain in FRP jacket, equal to lateral strain in concrete.

t_j : FRP jacket thickness.

d_j : diameter of FRP jacket.

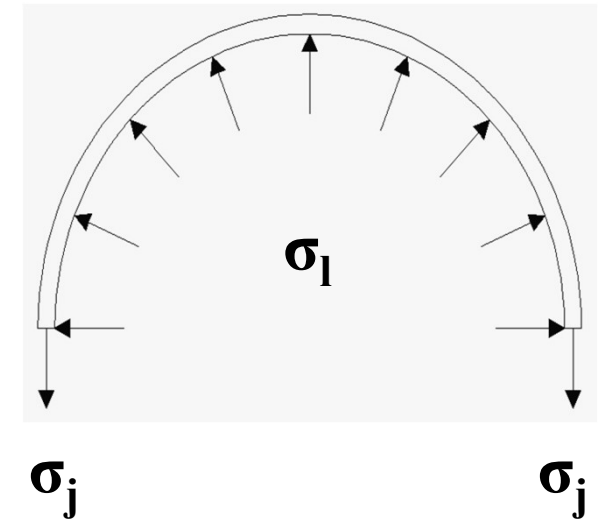

maximum lateral confinement pressure is :

$$f_l = \frac{1}{2} \rho_j E_j \varepsilon_{ju}$$

The confined concrete peak strength f_{cc} is computed as
(Mander et. al, 1988):

$$f_{cc} = f_{co} \cdot \left(2.254 \sqrt{1 + 7.94 \frac{f_l}{f_{co}}} - 2 \frac{f_l}{f_{co}} - 1.254 \right)$$

Where f_{co} is unconfined concrete strength.

Thériault and Neale (2000)

$$f'_{cc} = f'_c \left(1 + 2 \frac{f_{lfp}}{f'_c} \right)$$

Richart et al. (1929)

$$f'_{cc} = f'_c \left(1 + 4.1 \frac{f_{lfp}}{f'_c} \right)$$

Mander et al. (1988)

$$f'_{cc} = f'_c \left[2.254 \sqrt{1 + 7.94 \frac{f_{lfp}}{f'_c}} - 2 \frac{f_{lfp}}{f'_c} - 1.254 \right]$$

Pilakoutas and Mortazavi (1997)

$$f'_{cc} = f'_c \left(1.125 + 2.5 \frac{f_{lfp}}{f'_c} \right) \quad 2 \frac{f_{lfp}}{f'_c} \geq 0.1$$

Spoelstra and Monti (1999)

$$f'_{cc} = f'_c \left(0.2 + 3 \sqrt{\frac{f_{lfp}}{f'_c}} \right)$$

Predictive equation of FRP-confined concrete properties

Practical formula by Seible et al. (1995), experimentally derived:

$$\varepsilon_{ccu} = 0.004 + \frac{2.5 \rho_j f_j \varepsilon_{ju}}{f_{cc}}$$

Where:

ρ_j : volumetric ratio of FRP jacket.

f_j : FRP jacket strength.

ε_{ju} : effective ultimate strain.

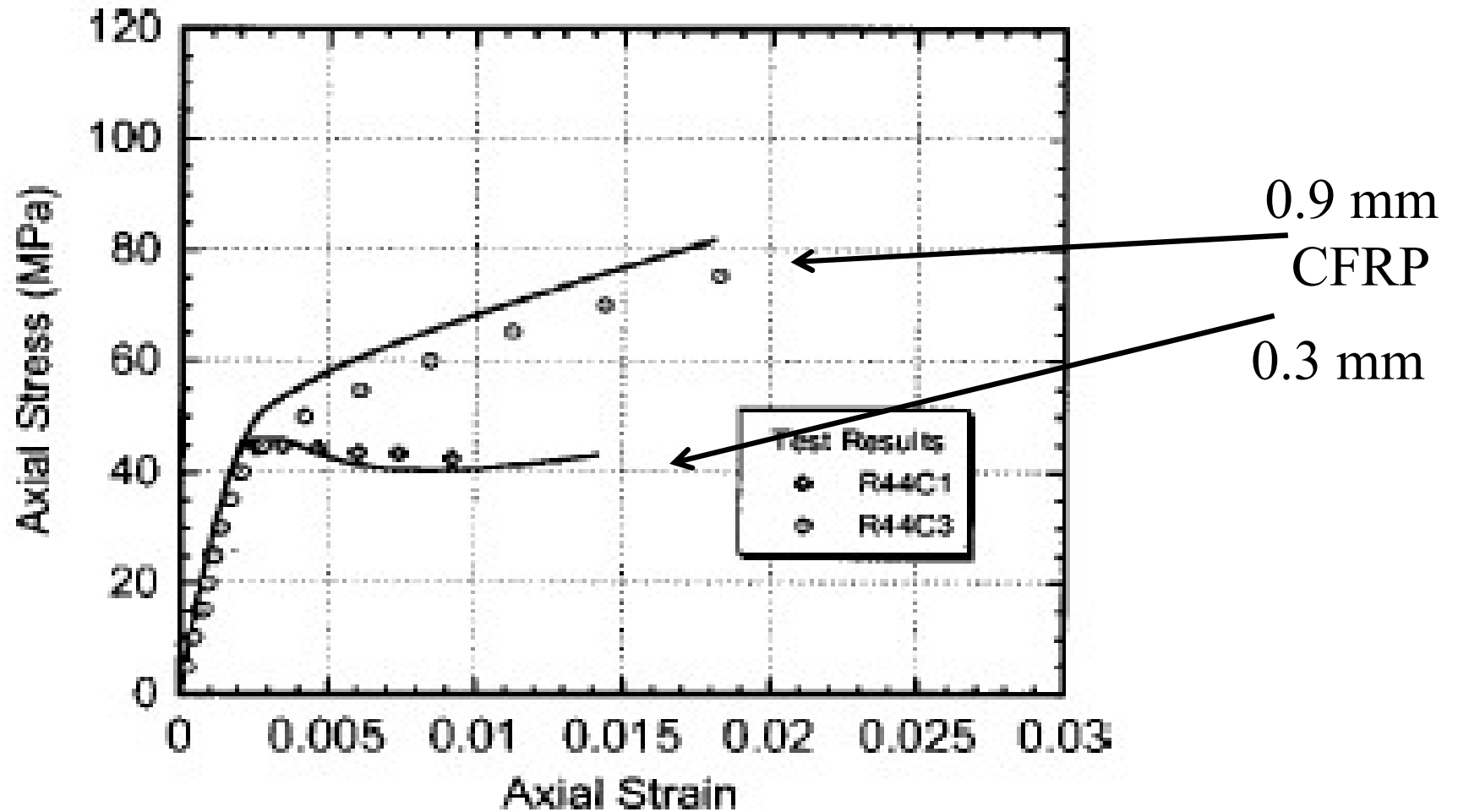

Comparison of analytical model with test results of Demers and Neal (1994)

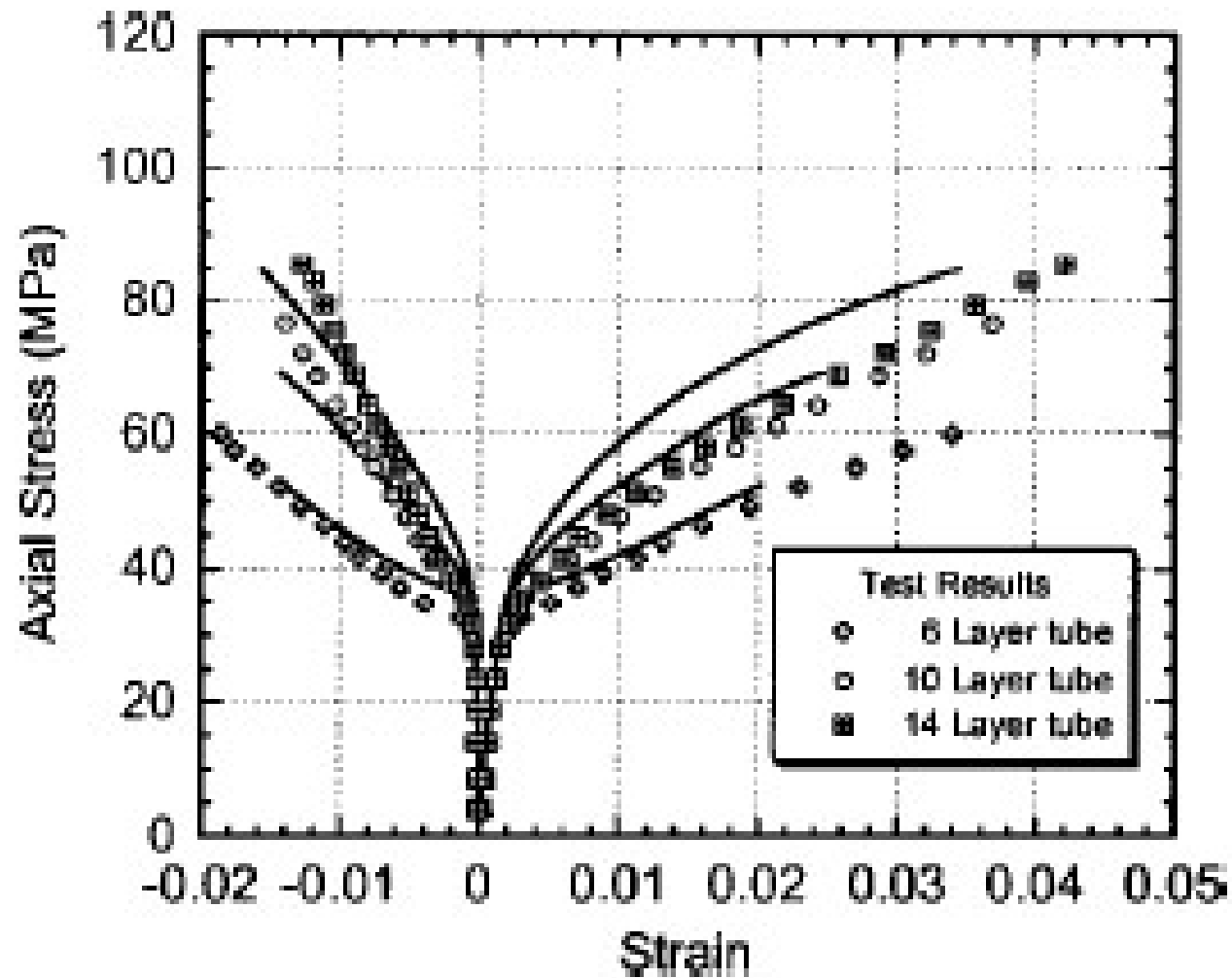

Comparison of analytical model with test results of Mirmiran and Shahawy (1997)

Column Strengthening

Rectangular Columns

- External FRP wrapping may be used with **rectangular** columns
 - There is far less experimental data available for rectangular columns
 - Strengthening is not nearly as effective

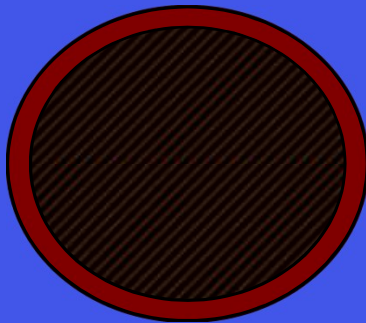

Confinement all around

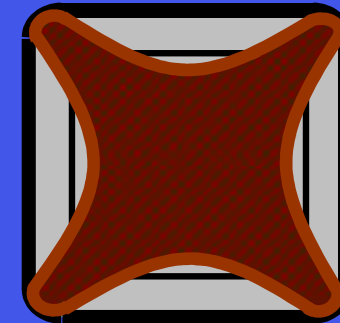

Confinement only in some areas

Rectangular Columns

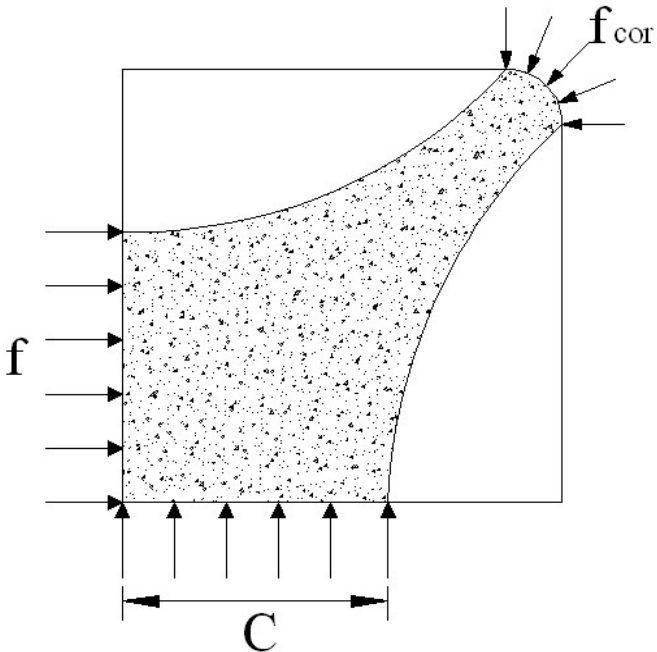
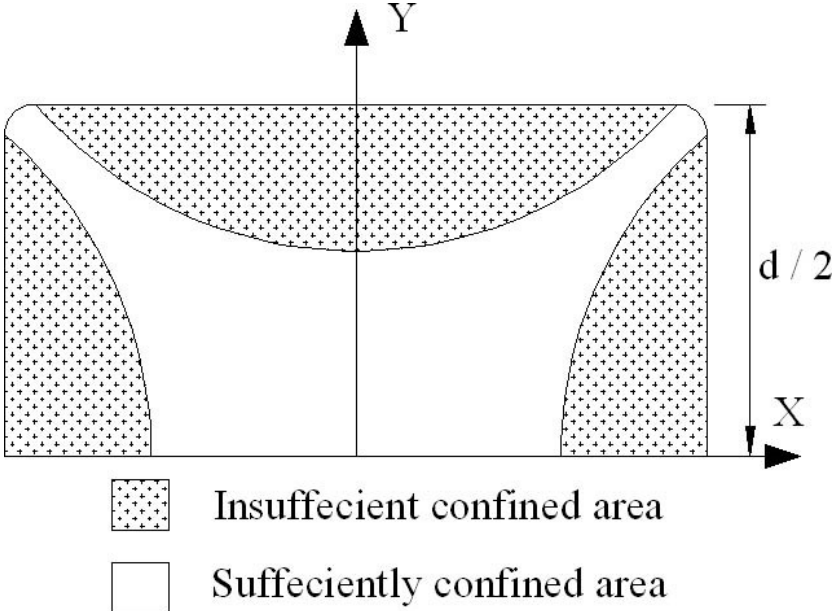

Rectangular Columns

$$f'_{cc} = f'_c \left[2.25 \sqrt{1 + 7.9 \frac{f_l}{f'_c}} - 2 \frac{f_l}{f'_c} - 1.25 \right]$$

$$f_l = \frac{1}{2} \rho_j E_j \varepsilon_{ju} K_a$$

K_a is the ,efficiency factor' or ,confinement effectiveness coefficient'

Rectangular Columns

$$\rho_j = \frac{2nt_f(b+h)}{bh}$$

$$K_a = 1 - \frac{(b-2r)^2 + (h-2r)^2}{3bh(1-\rho_g)}$$

Where: ρ_g is the longitudinal steel reinforcement ratio

**confining effect is questionable if
 $b/h > 1.5$ and/or b or $h > 900$ mm !!**

Column Confinement: Increasing deformation capacity in seismic regions

- Steel hoops
- Concrete or steel jackets

Increasing the confinement pressure in potential plastic hinge region

Column Confinement: Increasing deformation capacity in seismic regions

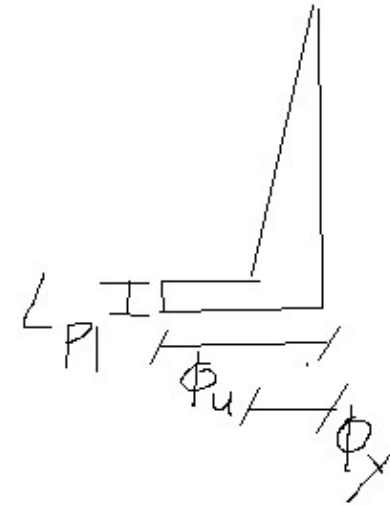
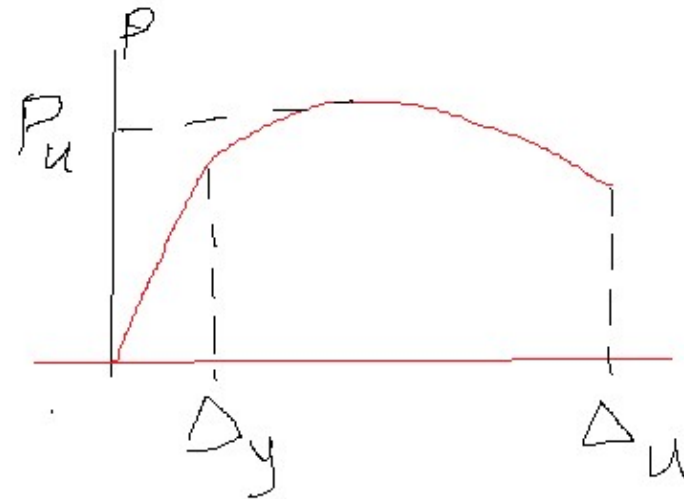
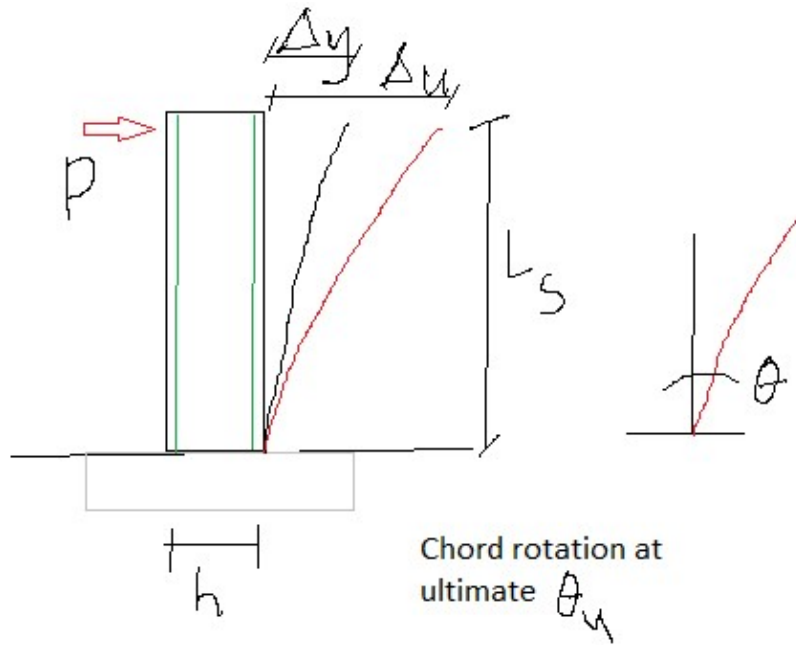

$$\theta_u \approx \theta_y + (\phi_u - \phi_y) L_{pl} \left(1 - 0.5 \frac{L_{pl}}{L_s}\right)$$

$$\theta_y \approx \phi_y \frac{L_s}{3} + 0.0013 \left[1 + 1.5 \frac{h}{L_s}\right] + 0.13 \phi_y \frac{f_y}{\sqrt{f_c}} d_b$$

d_b : rebar diameter

$$L_{pl} = 0.1 L_s + 0.17 h + \frac{0.24 f_y}{\sqrt{f_c}} d_b$$

$$\phi_u = \frac{E_c c c_u}{x_u}$$

Seismic Retrofitting of Concrete and Masonry Structures with Composite Materials

IIFC Webinar by Professor T. Triantafillou, University of Patras, Greece

<https://www.youtube.com/watch?v=laL8m3QECzQ&list=PLsdGDOBT-H8E9FWUgrURcto9jU9Pr0I45&index=5&t=0s>

Attachments

Laboratory competition

Content of the second exam

Program overview of the lectures and laboratory work

- Wednesday 25.10.2023, 15:45-17:30 (ETH Hönggerberg, HIL E7), Lecturer Yunus Harmanci
 - Lecture on Flexural Strengthening
 - Preparations for laboratory competition (Beam) and second written intermediate exam

- Wednesday 29.11.2023, 15:45-17:30 (Empa Dübendorf) Responsible Ali Jafarabadi
 - Meeting point at Busstation ETH Hönggerberg ETH Link 15:30!!
 - Application of Externally Bonded FRP Reinforcement (Confinement) for laboratory competition
 - Video of the beam failure test
 - Empa structural laboratory tour (if time available)

- Wednesday 13.12.2023, 15:45 – ca.18:00 (Empa Dübendorf) Responsible Ali Jafarabadi
 - Meeting point at Busstation ETH Hönggerberg ETH Link 15:30!!
 - Laboratory experiments and awarding of lab competition
 - Second written interim exam

First part of the laboratory competition: prediction of the failure load of this beam

Concrete
C35/45

Steel
 $f_s = 487 \text{ N/mm}^2$
 $f_t = 566 \text{ N/mm}^2$

CFRP
 $E_f = 150'000 \text{ N/mm}^2$

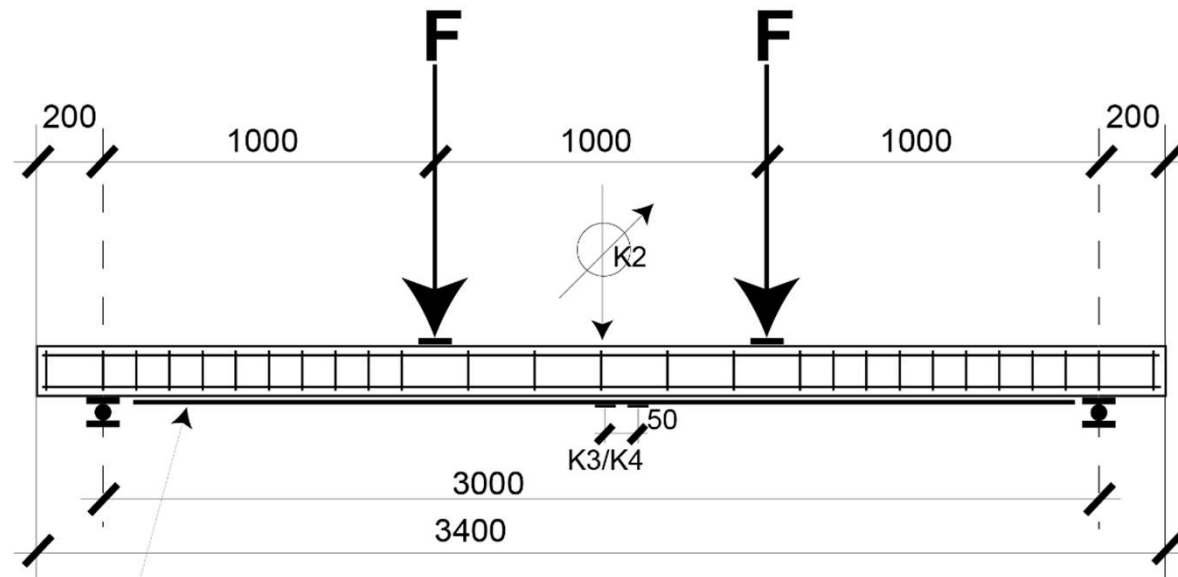

CFRP-strip S&P type CFK 150 / 2000
100x0.9mm, length 2850mm

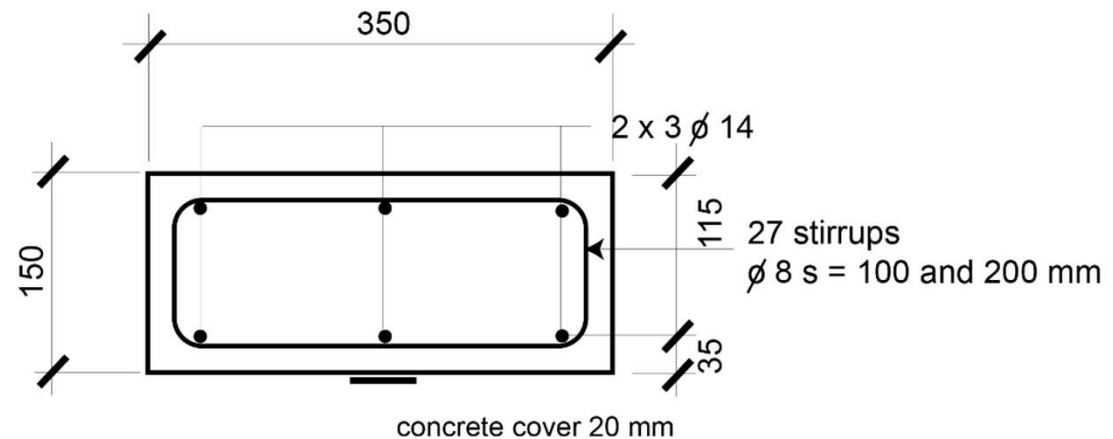

- $f_{c,cube}$ 68 days = 47.2 MPa ($f_c = 0.8 * f_{c,cube} = 37.8$ MPa)
- Assumption for calculations: concrete C35/45 ($f_{ctm} = 3.2$ MPa, $f_{ck} = 35$ MPa)

Cracking moment

$$M_{cr} =$$

$$F_{cr} =$$

$$\varepsilon_{f,cr} =$$

Yielding moment

$$M_y =$$

$$F_y =$$

$$\varepsilon_{f,y} =$$

Max moment

$$M_{max} =$$

$$F_{max} =$$

$$\varepsilon_{f,max} =$$

Compression tests on four concrete cylinders

Concrete cylinder 150x300mm

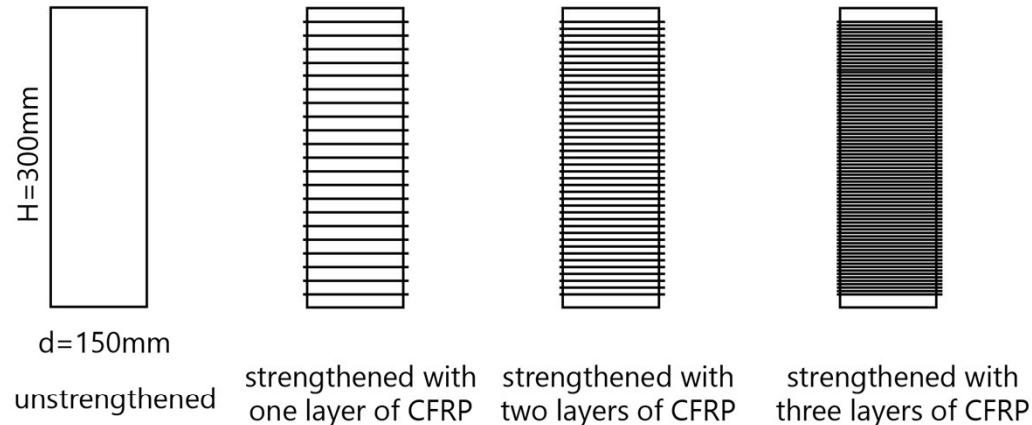

CFRP: S&P C-Sheet 240 200g/m²

Second part of the laboratory competition: prediction of the failure load of four cylinders

$$f_{c,cube,28} = 27.4 \text{ MPa}$$

Time schedule:

Casting on 22.09.2023
20.10.2023 after 28 Tagen: Testing of concrete cube compressive strength
29.11.2023: Application of CFRP sheet on the cylinders
13.12.2022: Failure tests

Lab competition

- Video of the experiment on the beam will be presented on 29.11.2023
- Lap experiments on the cylinders will be performed on 13.12.2023

- Who makes the best prediction? The best predictions are awarded with a price.
- Predictions (in kN):
 - Failure load of Beam (by 28.11.2023)**
 - Failure loads of Cylinders 1 to 4 (by 12.12.2023)**

- →Submission of the numbers by email to:
ali.jafarabadi@empa.ch

Content of the second exam on 13.12.2023, 15:45 - ca. 18:00!!! at Empa Dübendorf

Topics:

- Design of FRP profiles and all FRP structures
Lecture from 18.10.2023, Teacher Prof. Dr. M. Shahverdi
- Flexural strengthening of RC according to SIA166
Lecture from 01.11.2023, Teacher Dr. C. Czaderski
- Column confinement of RC
Lecture from 8.11.2023, Teacher Prof. Dr. M. Motavalli
- Externally bonded FRP reinforcement for metallic structures
Lecture from 15.11.2023, Teacher Dr. H. Heydarinouri

- Conceptual questions on the topics which were presented in the mentioned lectures. Furthermore, some calculations have to be performed.

- Time: 60 Minutes
- No laptops, tablets, smart phones etc.
- Only a calculator
- One A4 – Summary (both sides or two pages one side)

Example No. 1

Confinement properties : CFRP

$E_f = 300 \text{ GPa}$, $f_f = 1500 \text{ MPa}$, $\varepsilon_{ju} = 0.005$, $f_{c0} = 25 \text{ MPa}$

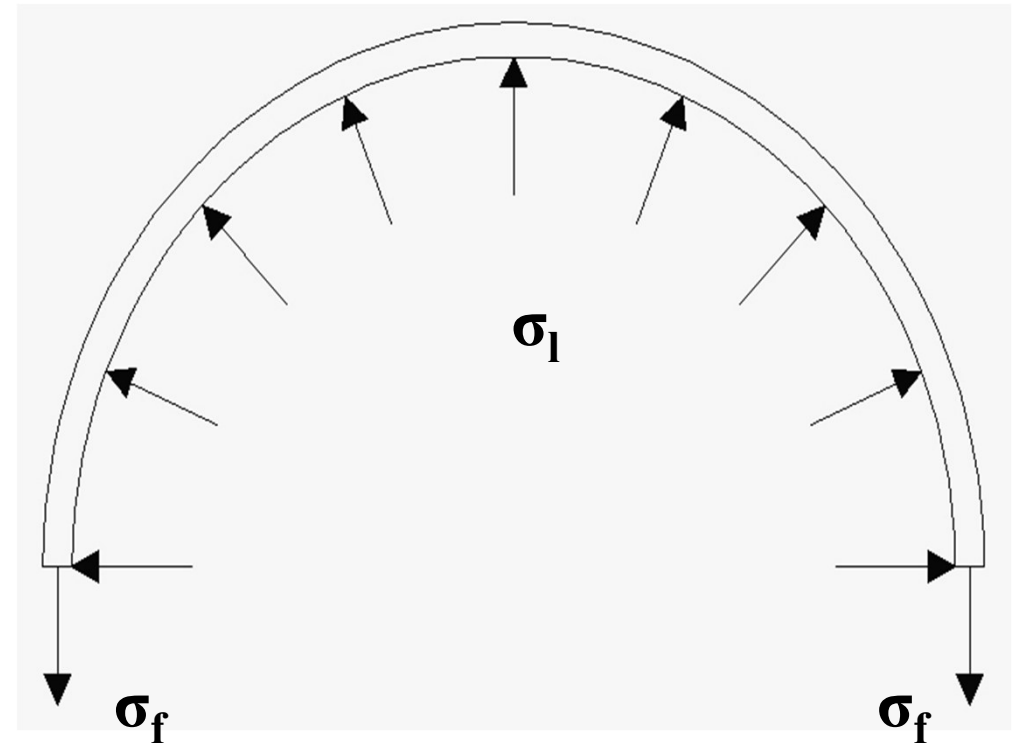
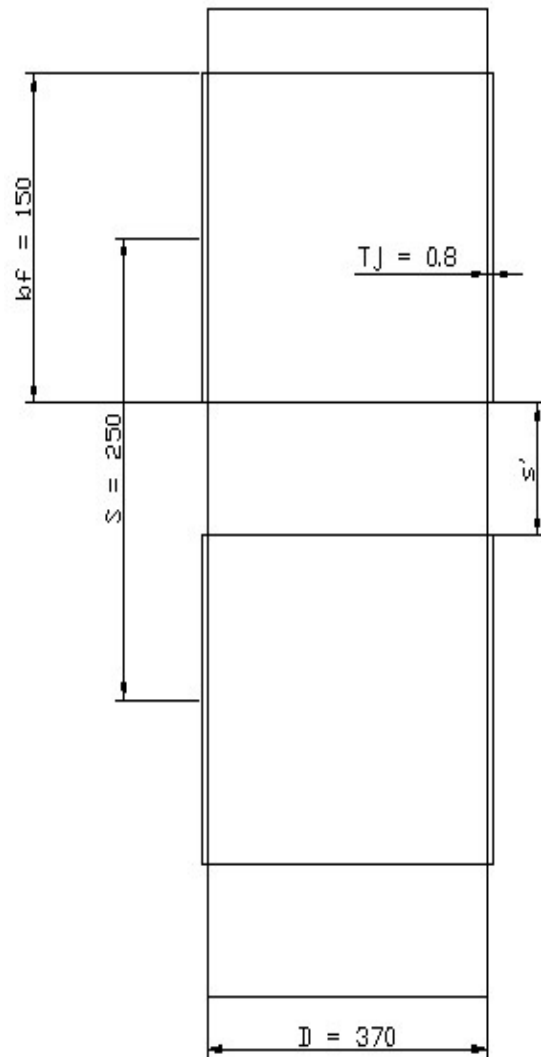

$$\sigma_l = \frac{1}{2} K_e \rho_j \sigma_j = \frac{1}{2} K_e \rho_j E_j \varepsilon_j \quad \rho_j = \frac{4t_j}{d_j}$$

$$\rho_j = (4t_j)/d_j = (4 \times 0.8)/370 = 0.00864$$

because the concrete is partially wrapped, less efficiency is obtained as both confined and unconfined zones exist. In this case, the confinement effectiveness coefficient may be obtained from equation below :

$$K_e = (1 - (s'/2D))^2$$

$$\text{where } s' = s - b_f = 250 - 150 = 100^{\text{mm}}$$

$$\rightarrow K_e = (1 - 0.1428)^2 = 0.734$$

Hence :

$$\sigma_1 = 951.26 \times 0.005 = 4.7 \text{ MPa}$$

$$\sigma_f = (\sigma_l d_j) / (2 t_j) = 1099.9 \text{ MPa} < f_f = 1500 \text{ MPa}$$

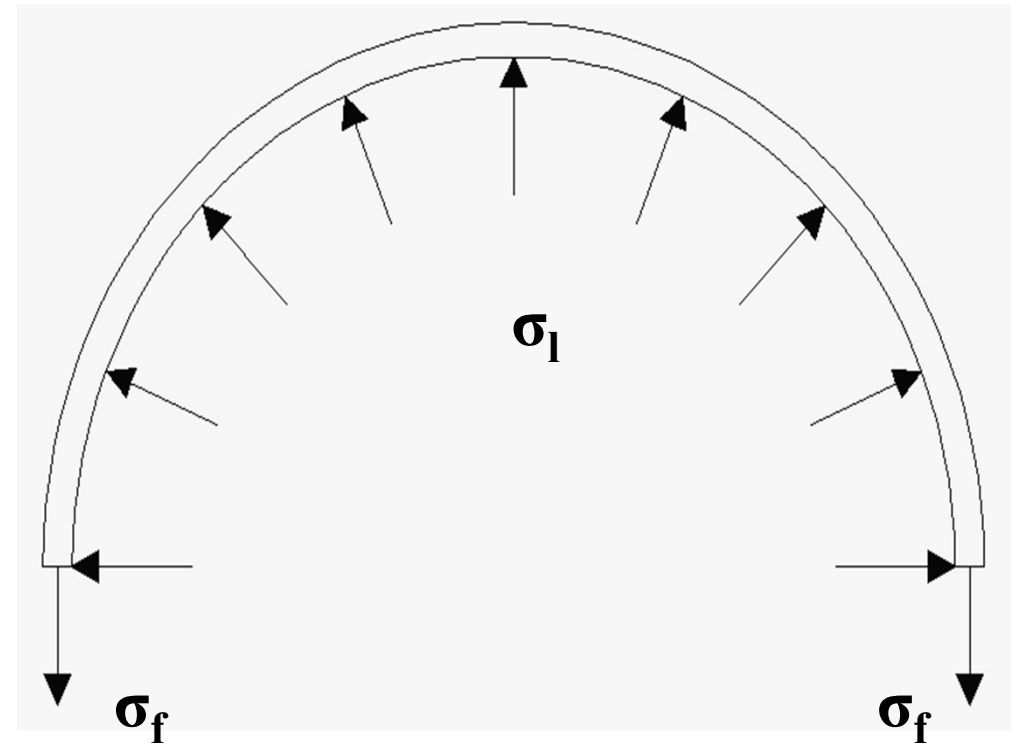

The ultimate confined concrete strain ϵ_{cu} can be computed from practical formula that has been developed by **seible** in 1995 :

$$\epsilon_{cu} = 0.004 + (2.5\rho_j f_j \epsilon_{ju} / f_{cc})$$

Where f_j is FRP jacket strength f_{cc} is confined concrete peak strength and derived from :

$$f_{cc} = f_{co} (2.254\sqrt{(1+7.94s)} - 2s - 1.254)$$

And $s = f_l / f_{co}$

f_{co} is unconfined concrete strength in MPa.

$$S = 4.7563/25 = 0.19$$

$$f_{cc} = 25 \times (3.57 - 0.38 - 1.254) = 48.4 \text{ MPa}$$

$$(2.5\rho_j f_j \varepsilon_{ju} / f_{cc}) = (2.5 \times 0.00864 \times 1500 \times 0.005) / 48.4 = 0.0033$$

$$\varepsilon_{cu} = 0.004 + 0.0033 = 0.0073$$

In 1999 another method has been suggested by **Monti and Spoelstra** based on observation in experimental tests through regression analyses the following equations were obtained :

$$f_{cu} = f_{co} (0.2 + 3\sqrt{f_l})$$

$$\varepsilon_{cu} = \varepsilon_{co} (2 + 1.25\bar{E}_c \varepsilon_{ju} \sqrt{f_l})$$

Where normalized values of the maximum confining stress and concrete modulus are :

$$f_l = \sigma_l / f_{co} \quad , \quad \bar{E}_c = E_c / f_{co}$$

$$f_1 = 4.7563/25 = 0.19$$

$$\bar{E}_c = 28000/25 = 1120$$

$$f_{cu} = 25 \times (0.2 + 3 \times 0.4358) = 37.6917 \text{ MPa}$$

$$\varepsilon_{cu} = 0.0035 \times (2 + 1.25 \times 1120 \times 0.005 \times 0.4358)$$

$$\varepsilon_{cu} = 0.01767 !$$

Canadian Guideline

Column Strengthening

- Design equations are largely **empirical** (from tests)
- ISIS equations are applicable for the following cases:

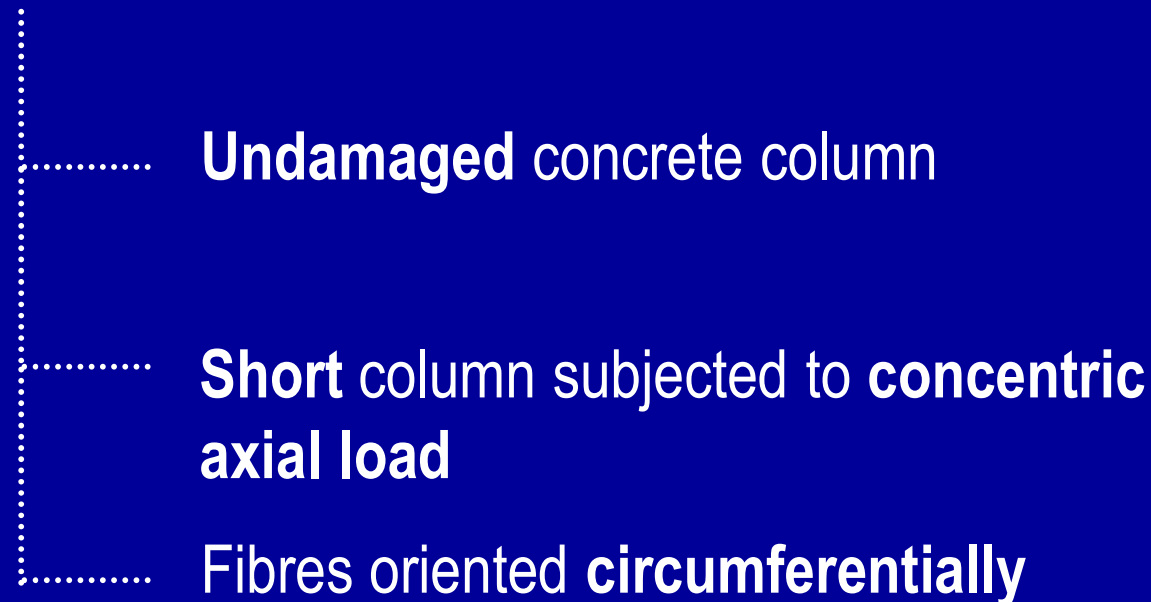

Column Strengthening

Circular Columns Slenderness Limits

- Strengthening equations only valid for non-slender columns:

$$\left[\frac{l_u}{D_g} \right] \leq \left[\frac{6.25}{\left[P_f / f'_c A_g \right]^{0.5}} \right]$$

A_g = gross cross-sectional area of column

f'_c = concrete strength

P_f = factored axial load

l_u = unsupported length

D_g = column diameter

Column Strengthening

Circular Columns Slenderness Limits

- Strengthening equations only valid for non-slender columns:

$$\left[\frac{l_u}{D_g} \right] \leq \left[\frac{6.25}{\left[P_f / f'_c A_g \right]^{0.5}} \right]$$

The axial load capacity is increased by the confining effect of the wrap



Column may become slender!



Ensure that column remains short

Column Strengthening

Circular Columns Confinement

- Based on equilibrium, the lateral confinement pressure exerted by the FRP, f_{lfrp} :

$$f_{lfrp} = \left[\frac{2 N_b \phi_{frp} f_{frpu} t_{frp}}{D_g} \right]$$

N_b = number of FRP layers

ϕ_{frp} = material resistance factor for FRP

f_{frpu} = ultimate FRP strength

t_{frp} = FRP thickness

Column Strengthening

Circular Columns Confinement

- The benefit of a confining pressure is to **increase** the *confined* compressive concrete **strength**, f'_{cc}

$$f'_{cc} = f'_c + k_1 f_{frp}$$

f'_c = ultimate strength of unconfined concrete

k_1 = empirical coefficient from tests

Column Strengthening

Circular Columns Confinement

- ISIS design guidelines suggest a modification to f'_{cc} :

$$f'_{cc} = f'_c + k_1 f_{f_{frp}} = f'_c (1 + \alpha_{pc} \omega_w)$$

α_{pc} = performance coefficient depending on:
(currently taken as 1.0)

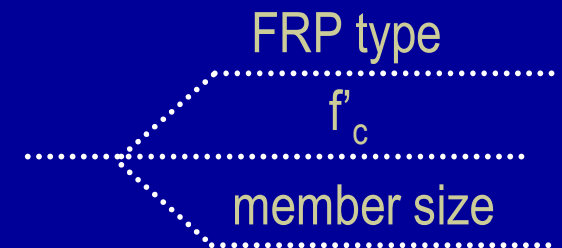

$$\omega_w = \frac{2 f_{f_{frp}}}{\phi_c f'_c}$$

Column Strengthening

Circular Columns Confinement Limits

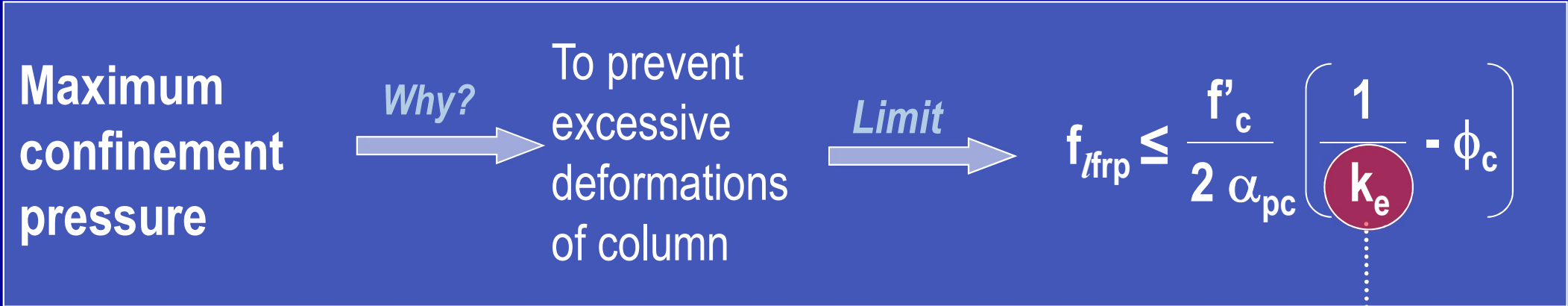
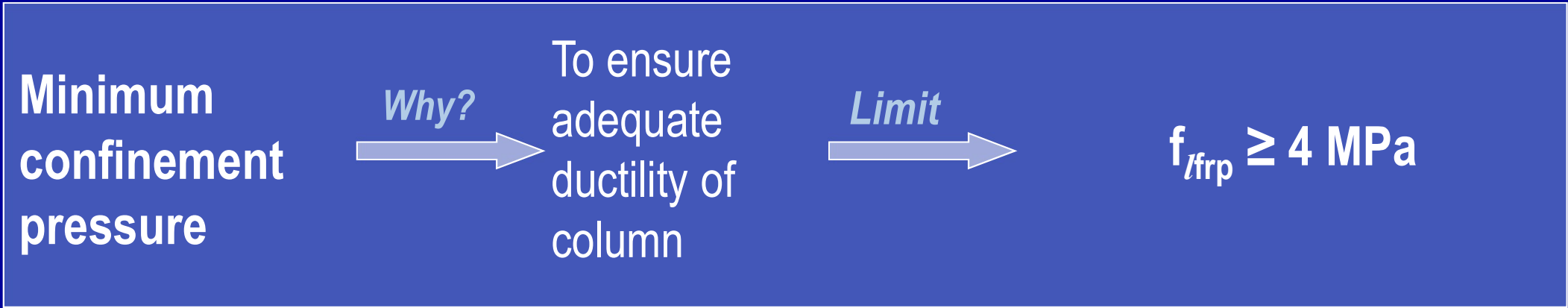

= 0.85 (Strength reduction factor to account for unexpected eccentricities)

Column Strengthening

Circular Columns Axial Load Resistance

- Factored axial load resistance for an FRP-confined reinforced concrete column, P_{rmax} :

$$P_{rmax} = k_e [\alpha_1 \phi_c f'_{cc} (A_g - A_s) + \phi_s f_y A_s]$$

*Same equation as for conventionally RC column, except includes **confined** concrete strength, f'_{cc}*

Example No. 2

Based on canadian guideline

Column Strengthening

Example

Problem statement

Determine the FRP wrap details for an RC column as described below

Information

RC column factored axial resistance (pre-strengthening) = 3110 kN

New axial live load requirement $P_L = 1550$ kN

New axial dead load requirement $P_D = 1200$ kN

New factored axial load, $P_f = 4200$ kN

$$l_u = 3000 \text{ mm}$$

$$D_g = 500 \text{ mm}$$

$$A_g = 196350 \text{ mm}^2$$

$$A_{st} = 2500 \text{ mm}^2$$

$$f'_c = 30 \text{ MPa}$$

$$f_{frpu} = 1200 \text{ MPa}$$

$$t_{frp} = 0.3 \text{ mm}$$

$$f_{frp} = 0.75$$

$$f_y = 400 \text{ MPa}$$

Column Strengthening

Example

Solution

Step 1: Check if column remains short after strengthening

$$\left[\frac{l_u}{D_g} \right] \leq \left[\frac{6.25}{\left[\frac{P_f}{f'_c A_g} \right]^{0.5}} \right]$$

$$\left[\frac{3000}{500} \right] \leq \left[\frac{6.25}{\left[\frac{4200000}{(30 \times 196350)} \right]^{0.5}} \right]$$

$$6 \leq 7.4$$

⇒ OK

Column Strengthening

Example

Solution

Step 2: Compute required confined concrete strength, f'_{cc}

Take equation 5-9 and rearrange for f'_{cc} :

$$P_{rmax} = k_e [\alpha_1 \phi_c f'_{cc} (A_g - A_s) + \phi_s f_y A_s]$$

$$\Rightarrow f'_{cc} = \frac{\left(\frac{P_f}{k_e} - \phi_s f_y A_s \right)}{\alpha_1 \phi_c (A_g - A_s)}$$

Column Strengthening

Example

Solution

Step 2: Compute required confined concrete strength, f'_{cc}

$$\alpha_1: \dots \alpha_1 = 0.85 - 0.0015f'_c = 0.85 - 0.0015(30) = 0.81$$

$$f'_{cc}: \dots f'_{cc} = \frac{\left(\frac{4200000}{0.85} \right) - 0.85(400)(2500)}{0.81(0.6)(196350 - 2500)}$$

$$f'_{cc} = 43.4 \text{ MPa}$$

Column Strengthening

Example

Solution

Step 3: Compute volumetric strength ratio, ω_w

$$f'_{cc} = f'_c + k_1 f_{f_{frp}} = f'_c (1 + \alpha_{pc} \omega_w)$$

$$\omega_w = \frac{\left(\frac{f'_{cc}}{f'_c} - 1 \right)}{\alpha_{pc}} = \frac{\left(\frac{43.4}{30} - 1 \right)}{1}$$

$$\omega_w = 0.447$$

Column Strengthening

Example

Solution

Step 4: Compute required confinement pressure, f_{lfrp}

$$\omega_w = \frac{\rho_{frp} \phi_{frp} f_{frpu}}{\phi_c f'_c} = \frac{2 f_{lfrp}}{\phi_c f'_c}$$

f_{lfrp} :

$$f_{lfrp} = \frac{\omega_w \phi_c f'_c}{2} = \frac{0.447 (0.6) (30)}{2}$$

$$f_{lfrp} = 4.02 \text{ MPa}$$

Column Strengthening

Example

Solution

Step 4: Compute required confinement pressure, $f_{/frp}$

Check $f_{/frp}$ again confinement limits:

⇒ Minimum: $f_{/frp} = 4.02 > 4.0$

⇒ Maximum: $f_{/frp} = 4.02 < \frac{f'_c}{2 \alpha_{pc}} \left(\frac{1}{k_e} - \phi_c \right)$

$$f_{/frp} = 4.02 < \frac{30}{2(1)} \left(\frac{1}{0.85} - 0.6 \right) = 8.65$$

⇒ OK, limits met

Column Strengthening

Example

Solution

Step 5: Compute required number of FRP layers

$$f_{/frp} = \left[\frac{2 N_b \phi_{frp} f_{frpu} t_{frp}}{D_g} \right]$$

$$N_b = \left[\frac{f_{/frp} D_g}{2 \phi_{frp} f_{frpu} t_{frp}} \right] = \left[\frac{4.02 (500)}{2 (0.75) (1200) (0.3)} \right]$$

$$N_b = 3.72$$

⇒ Use 4 layers

Column Strengthening

Example

Solution

Step 6: Compute factored axial strength of FRP-wrapped column

$$f_{lfrp} : \dots \dots \dots f_{lfrp} = \left[\frac{2 N_b \phi_{frp} f_{frpu} t_{frp}}{D_g} \right] = 4.32 \text{ MPa}$$

$$\omega_w : \dots \dots \dots \omega_w = \frac{2 f_{lfrp}}{\phi_c f'_c} = 0.48$$

Column Strengthening

Example

Solution

Step 6: Compute factored axial strength of FRP-wrapped column

f'_{cc} : $f'_{cc} = f'_c (1 + \alpha_{pc} \omega_w) = 44.4 \text{ MPa}$

P_{rmax} : $P_{rmax} = k_e [\alpha_1 \phi_c f'_{cc} (A_g - A_s) + \phi_s f_y A_s]$

$P_{rmax} = 4230 \text{ kN} > P_f = 4200 \text{ kN}$

Note: Additional checks should be performed for creep and fatigue

Example No. 3

Seismic Retrofitting of Hotel Azadi in Tehran

Owner: The Tourism and Recreational Centers Organization, Mostazafan foundation, Iran

Contractor: Cathic Shanghai (China)

Engineering design (consultant): Snteam GmbH (Switzerland)

Fibre Provider: Sika AG (China and Switzerland)

Damper provider: FIP (Italy)

Local supervisor: Radyab Co (Iran)

Consultant to local supervisor: Empa (Switzerland)



Columns at lobby level have to be strengthened

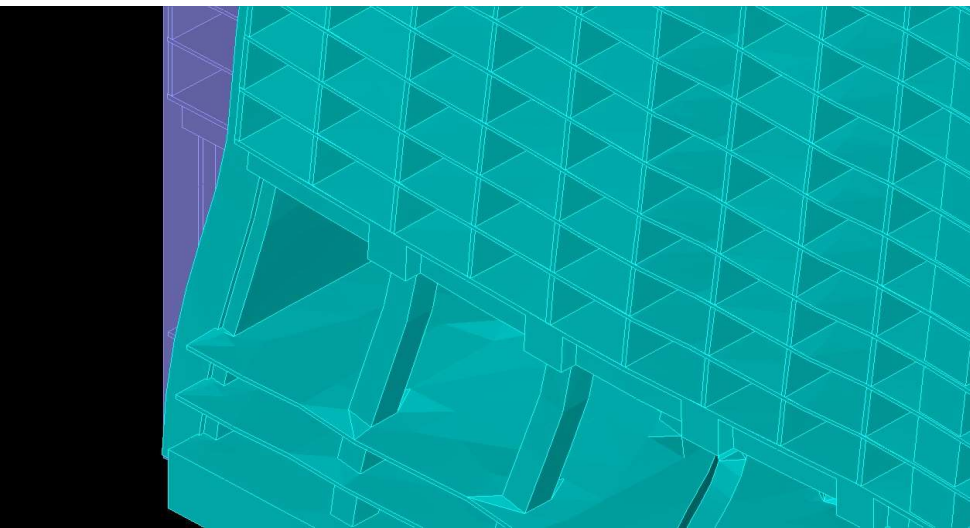
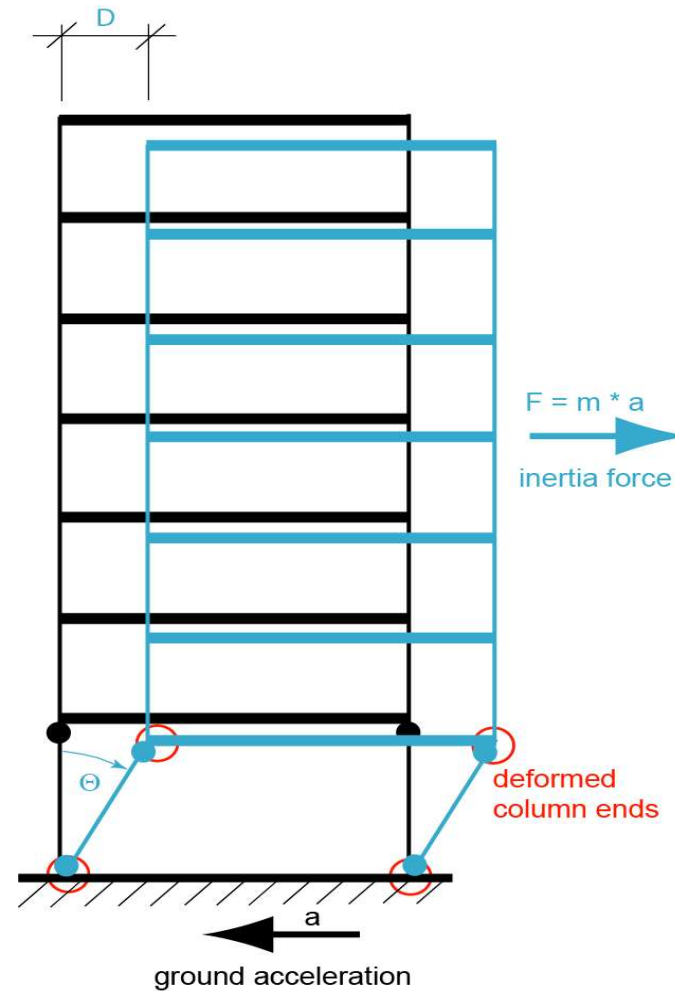

Externally Bonded FRP: Confinement

Azadi Hotel in Tehran, Main Tower, South Elevation

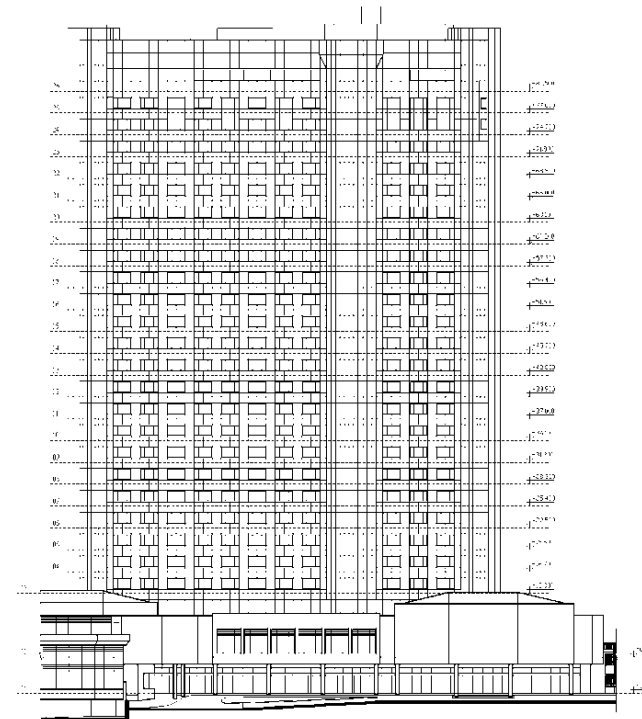

Azadi Hotel in Tehran

- Designed & constructed in 1970's
- Owner: The Tourism and Recreational Centres Organization, Moje-Seyahat Capitalization and Development Co. (Inc.), Tehran, Iran
- 28 stories (2 underground, 26 floors), approximate 88 m height
- 11 x 32 m approximate plan of the main tower
- Reinforced concrete (RC) shear walls and columns
- Continuous RC shear walls from 2nd to 28th floors (room partitioning)
- 15 circular and rectangular columns in Lobby and 1st Floor (1.4 m diameter, 1.2 X 1.4 m respectively, some columns with 10.5 m height)

Ground Floor Plan

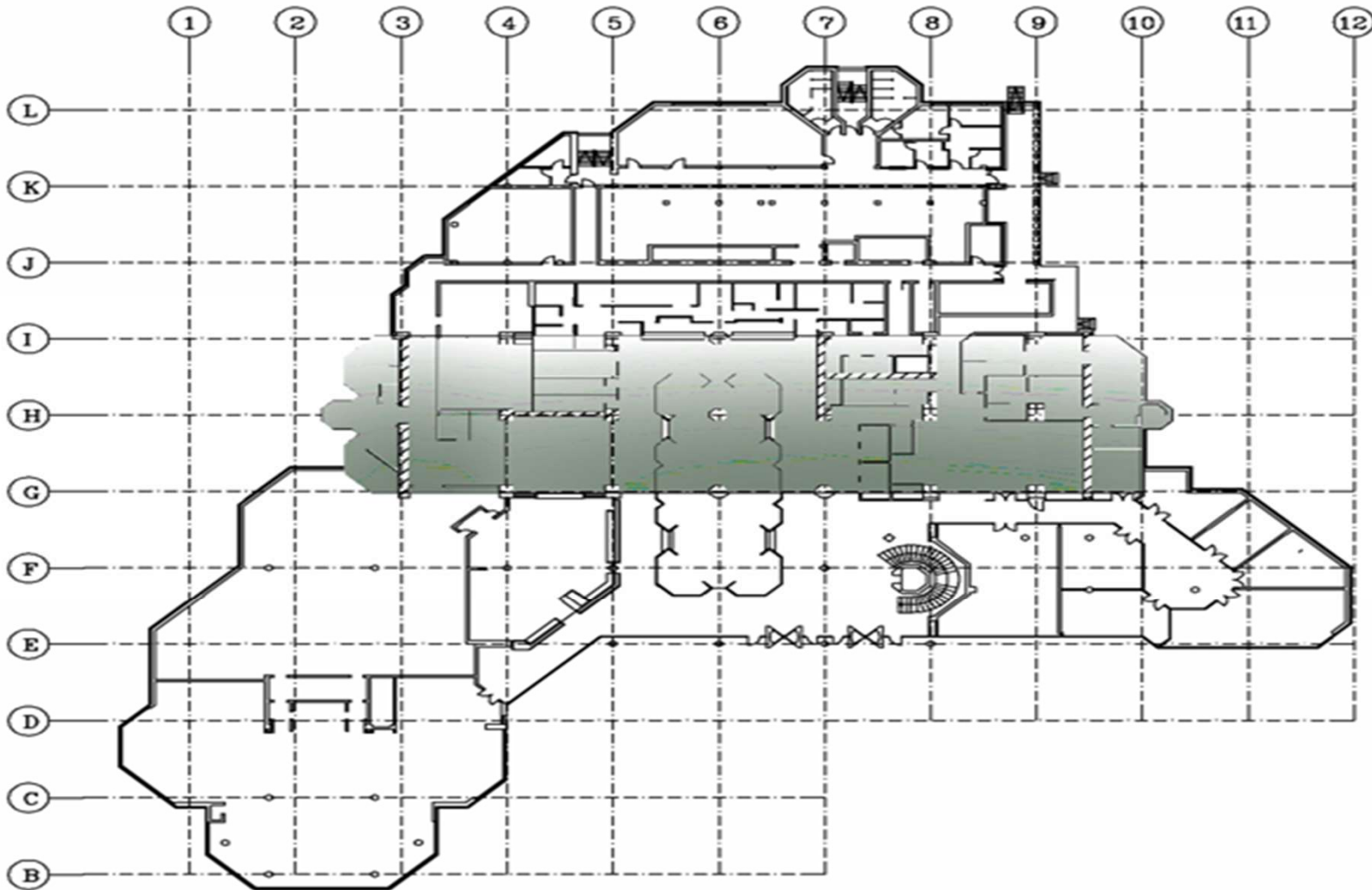

24. and 25. Floor Plan

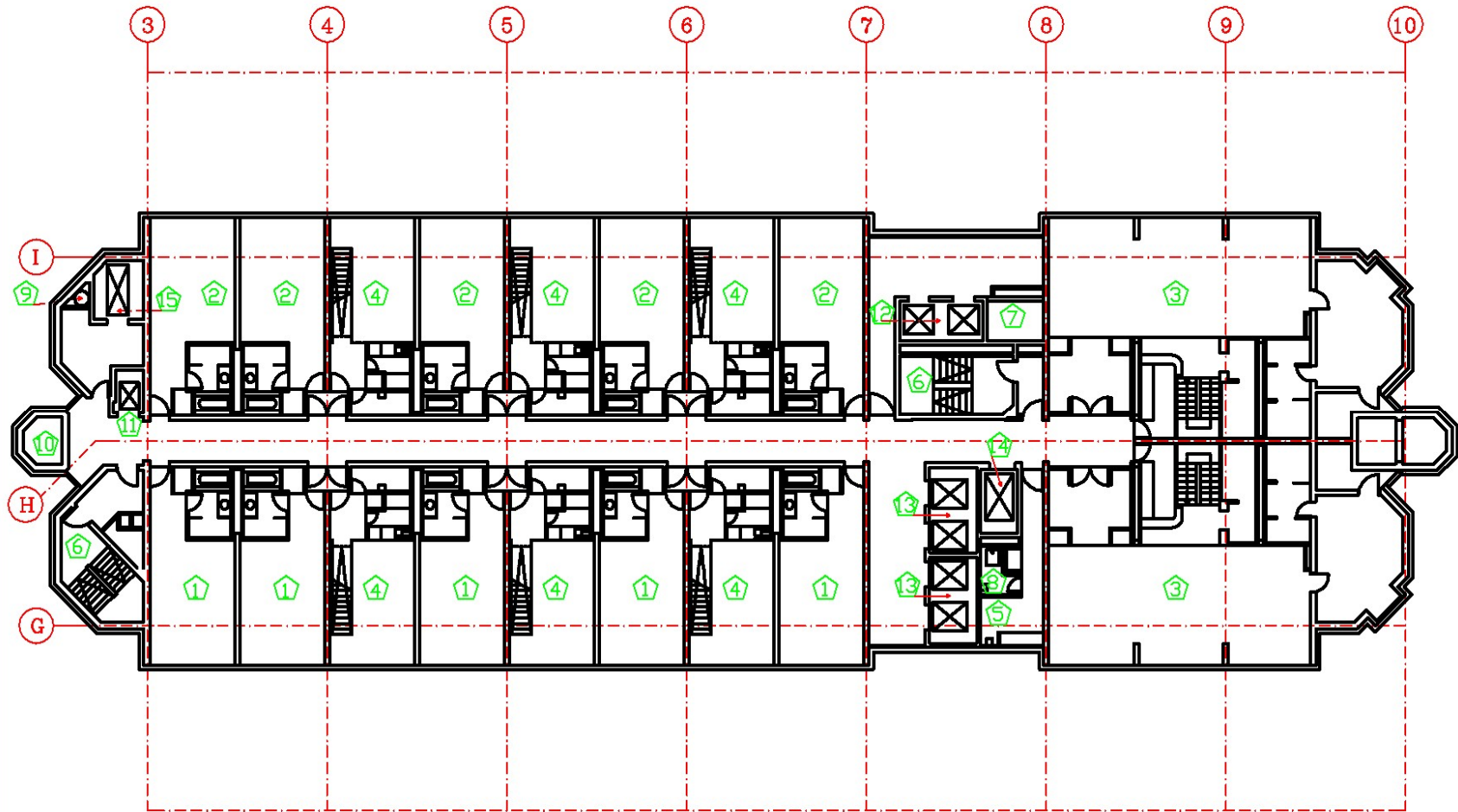

Seismic Retrofitting Design

- Steel Bracings at the Ground (lobby) and First floor
- Fluid Dampers at the Ground and First Floor
- Wrapping of Columns and Shear walls with CFRP Sheets in the Ground, First floor and Underground



Externally Bonded FRP: Confinement



Fibre Composites, FS23

Masoud Motavalli

Used carbon fibre sheets for strengthening of columns and shear walls

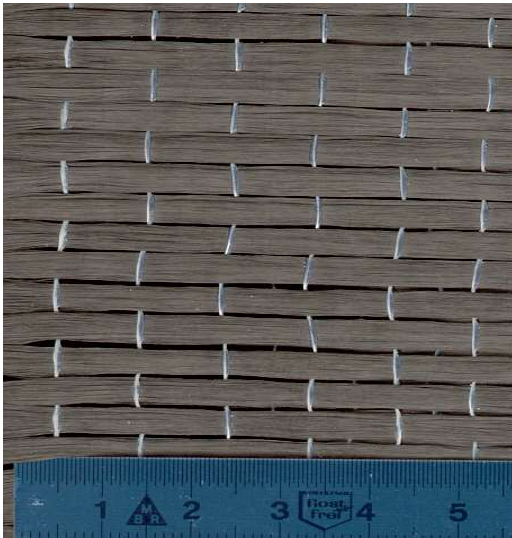

Type A



Type B



osites, FS23

Masoud Motavalli

Demonstration of application of CFRP sheets

Round column with a diameter of 1.4 m on the ground floor, 13.04.2008



Externally Bonded FRP: Confinement

Fibre Composites, FS23

Masoud Motavalli

Pull-off tests

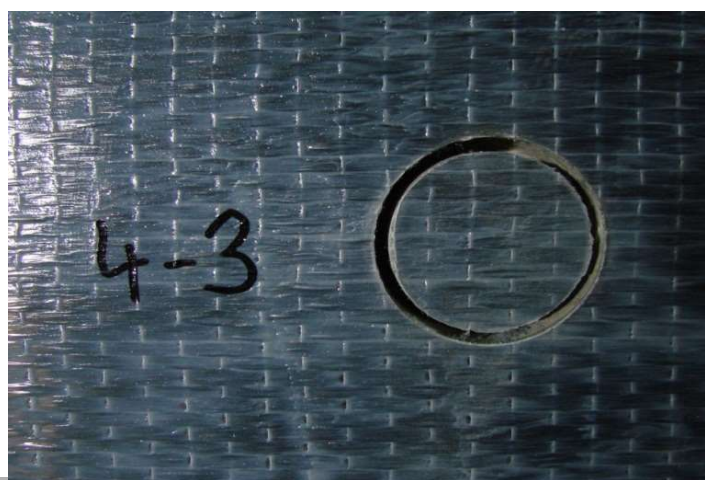

Externally Bonded FRP: Confinement

Fibre Composites, FS23

Masoud Motavalli

Results of the pull-off test

- Generally, failure in the concrete
- Mostly, concrete has a very low tensile strength
- A roughly correspondence between pull-off tester of Empa and the contractor
- Pull-off tests are recommended as quality control for the bond of the CFRP fabrics

Laboratory Tests:

Tests on Scaled Columns 1:3

Static Cyclic Tests at Empa

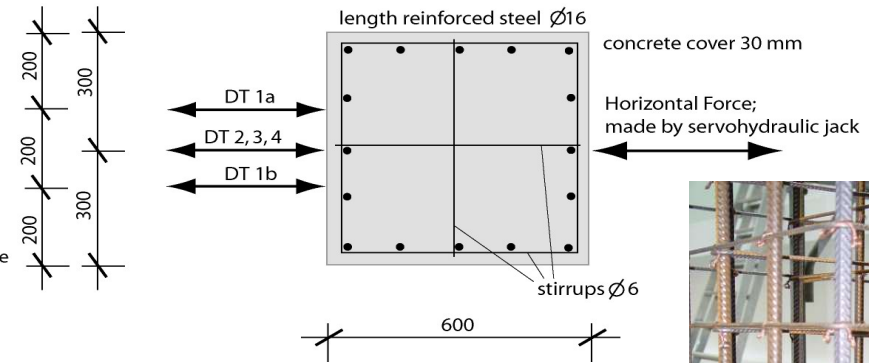
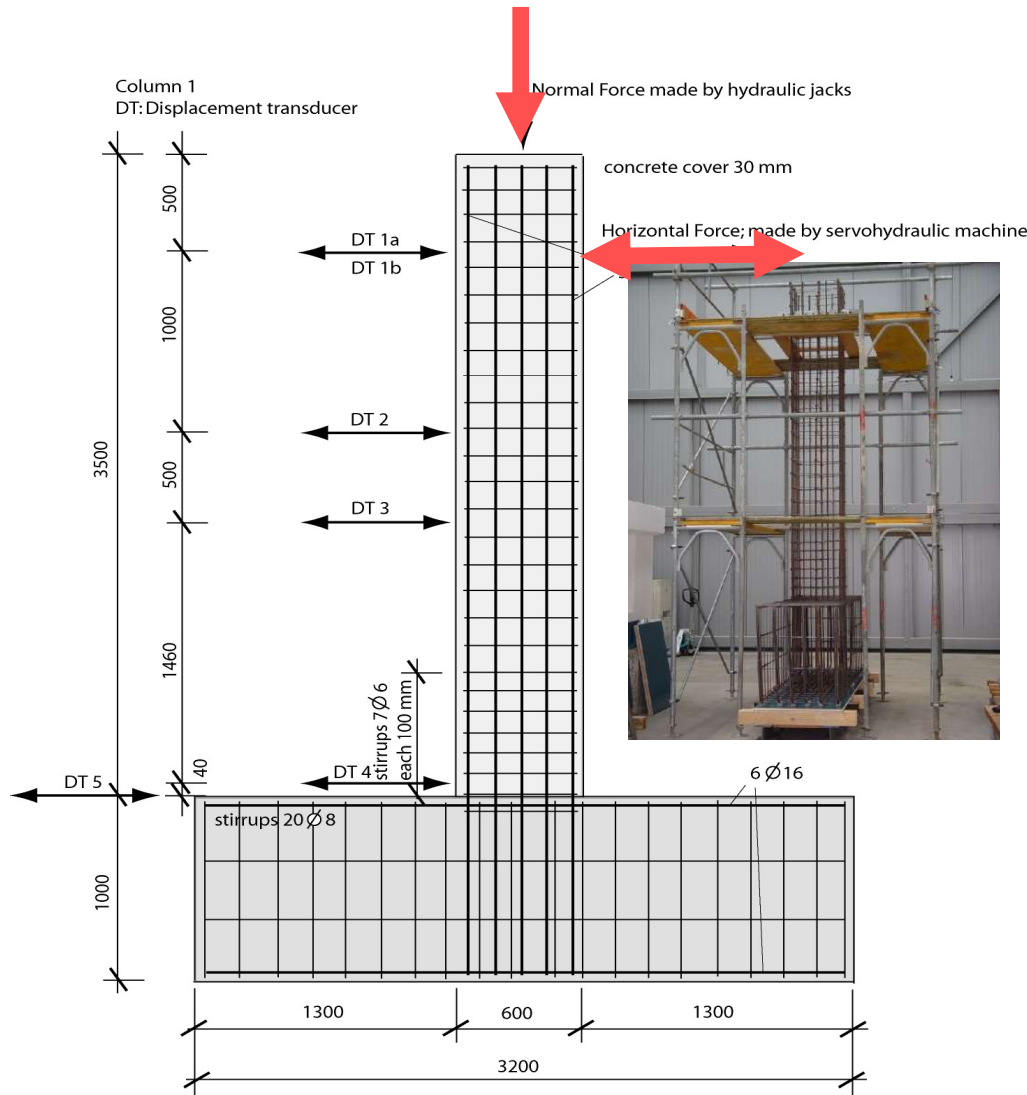

- Height of column: 3.50m
- Loading point @ 3.00m
- Height of foundation: 1.0m
- Cross section of column: 0.60m x 0.60m
- Corner rounding: 25mm
- Longitudinal reinforcement: 16Ø16mm
- Transverse reinforcement: stirrups Ø6mm @ 130 mm
- Ø6mm @ 100 mm (plastic hinge region; 20% of column height (*Bachmann et al.*))

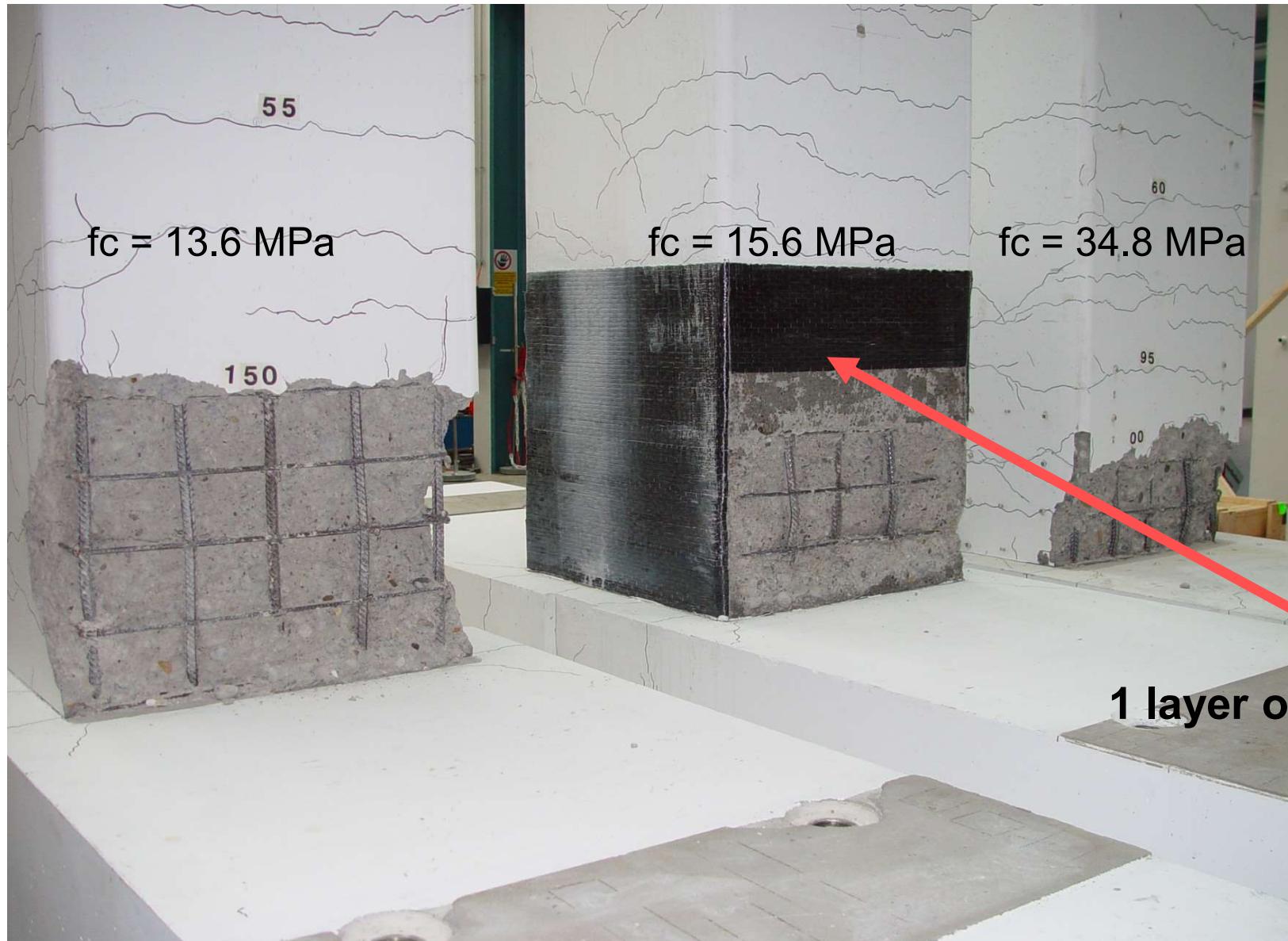

1 layer of CFRP sheet

Testing of a Scaled Column at Empa (600 X 600 mm), Appr. 4 m Height



Externally Bonded FRP: Confinement

Fibre Composites, FS23

Masoud Motavalli

Static Cyclic Tests at Empa

$f_c = 13.6 \text{ MPa}$

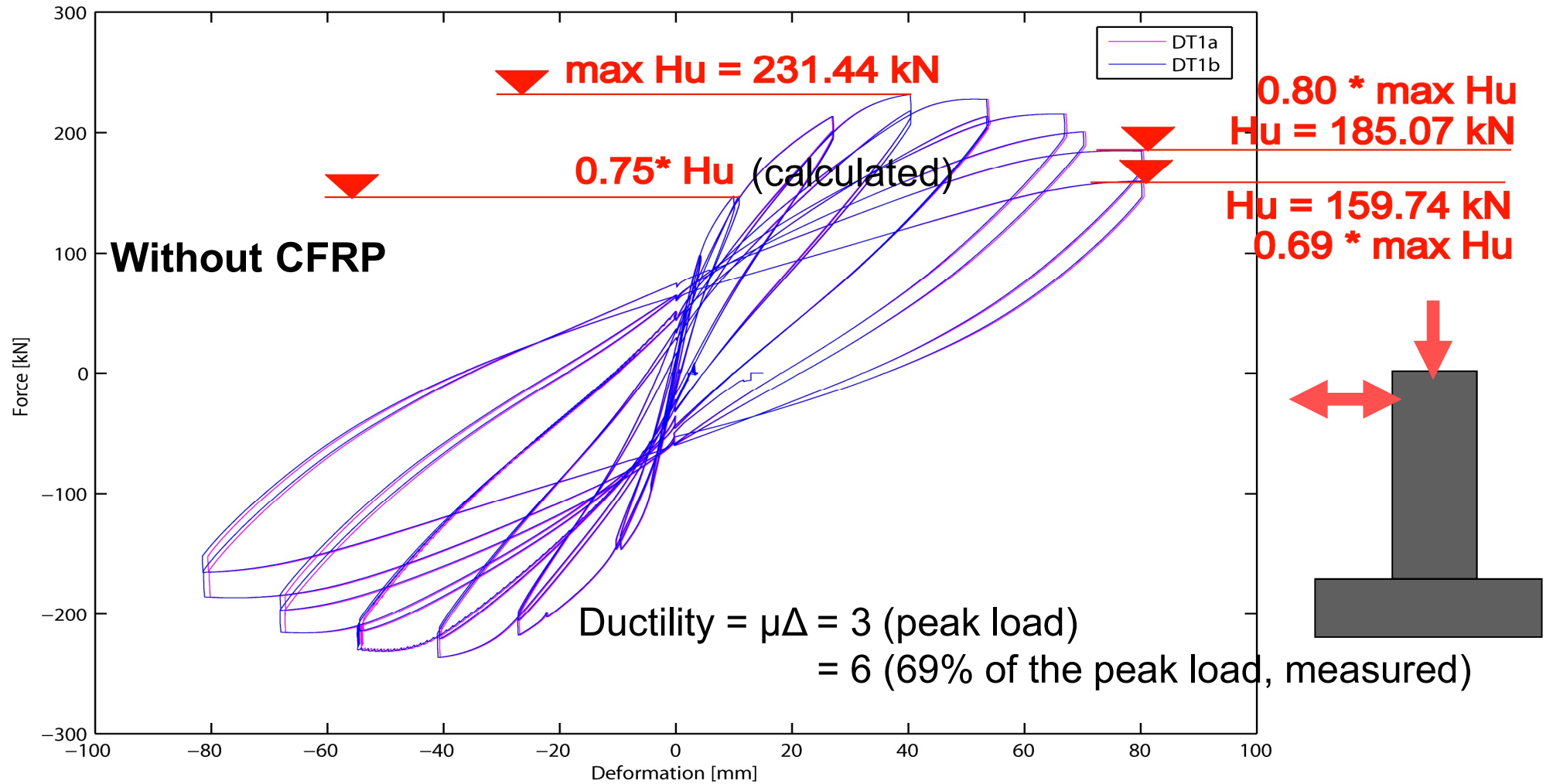

Static Cyclic Tests at Empa

$f_c = 15.6 \text{ MPa}$

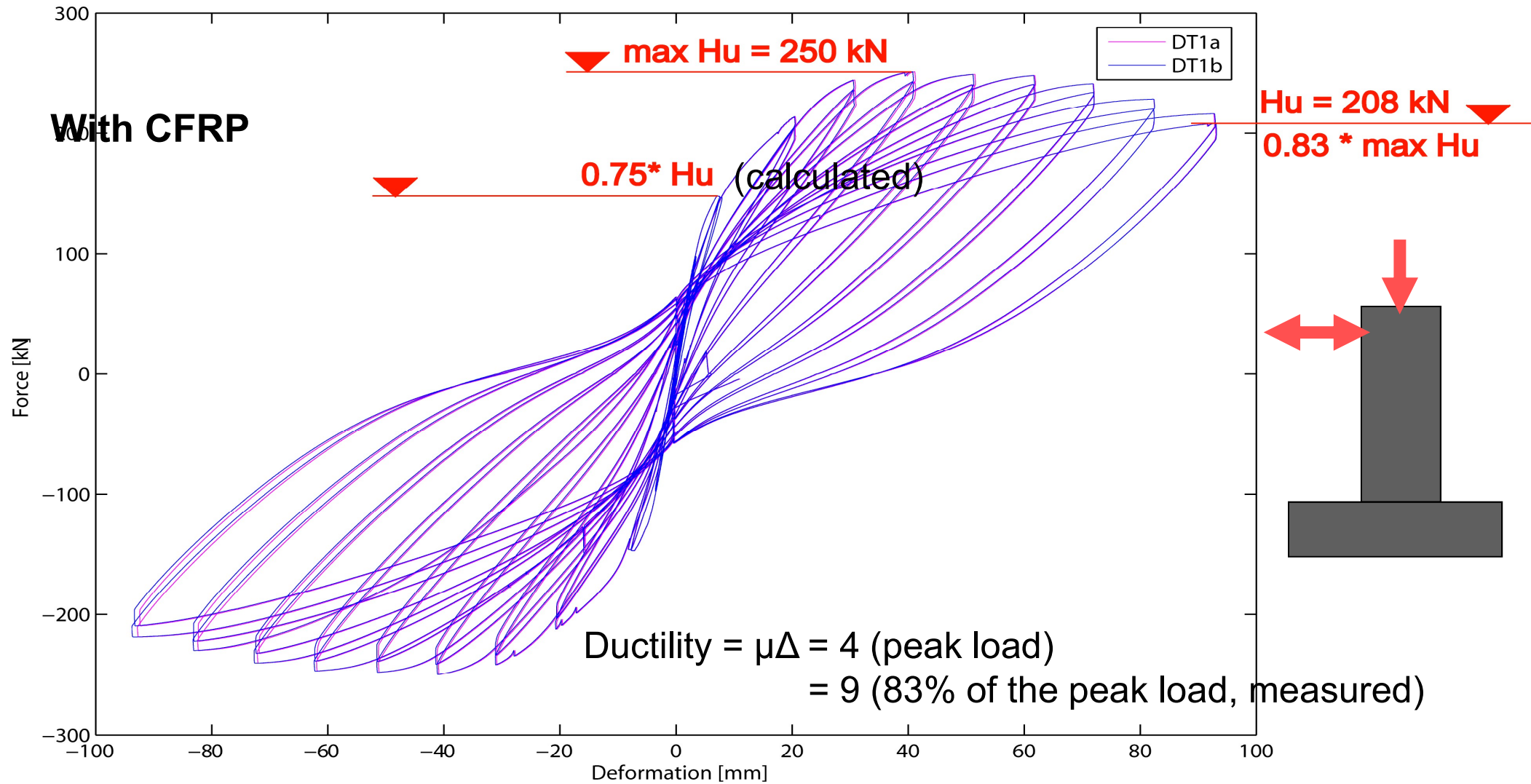

Test vs. Calculations for the Empa Test

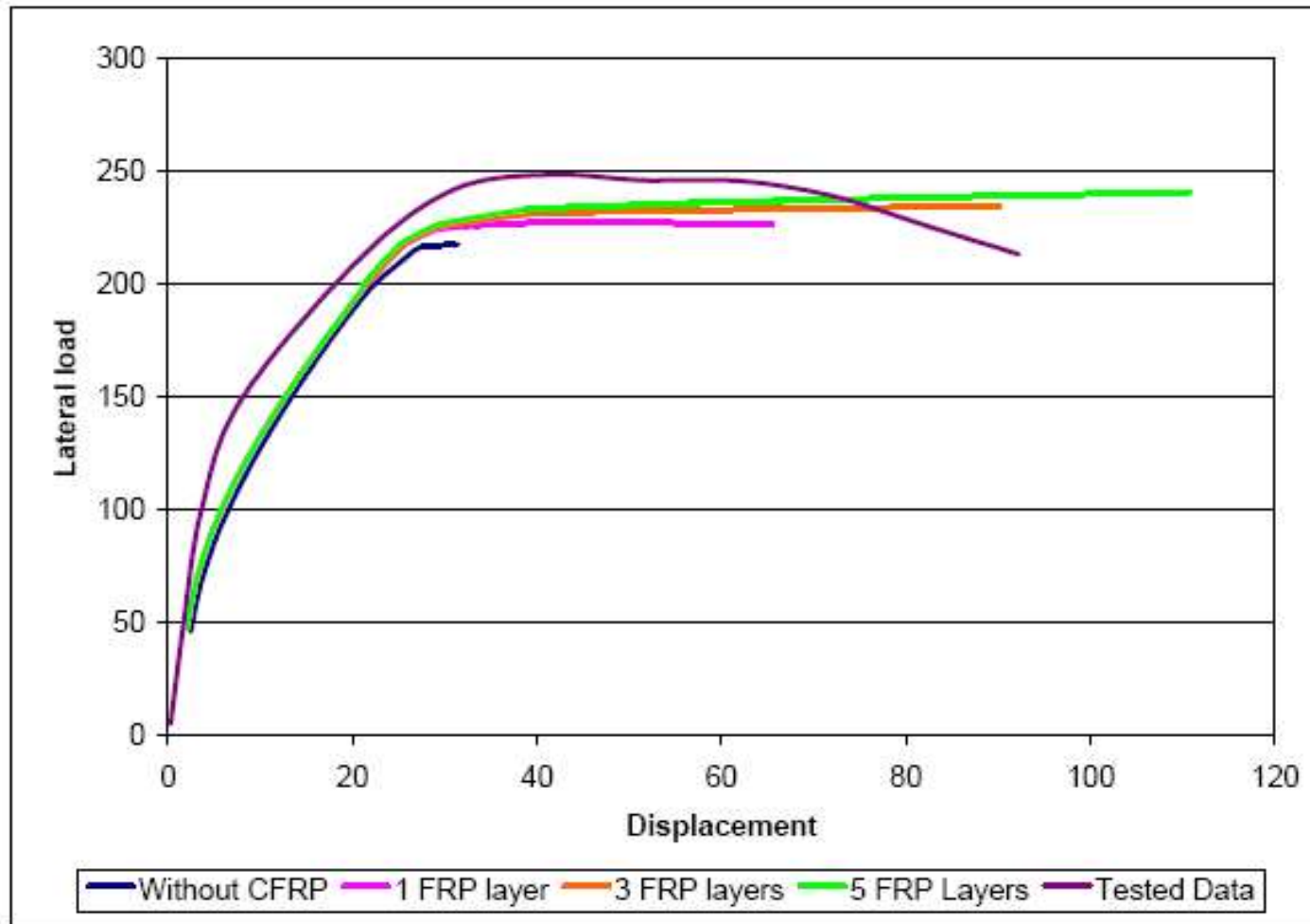

Column properties	
Concrete	17 Mpa Cylinder 19.6 MPa Cube
Side length	600 mm
Corner rounding	25 mm

Wrap properties	
Thickness (mm)	0.293
E-modulus (Mpa)	231000
Ultimate strain	0.0164

Reinforcement	
Longitudinal	16 # 16
Transverse	3 # 6
Stirrup Spacing (in hinge)	100 mm
Stirrup Spacing (in rest)	150 mm
Steel Strength (MPa)	500.6

Calculation of a Hotel Azadi Column Using Calibrated Analytical Procedure

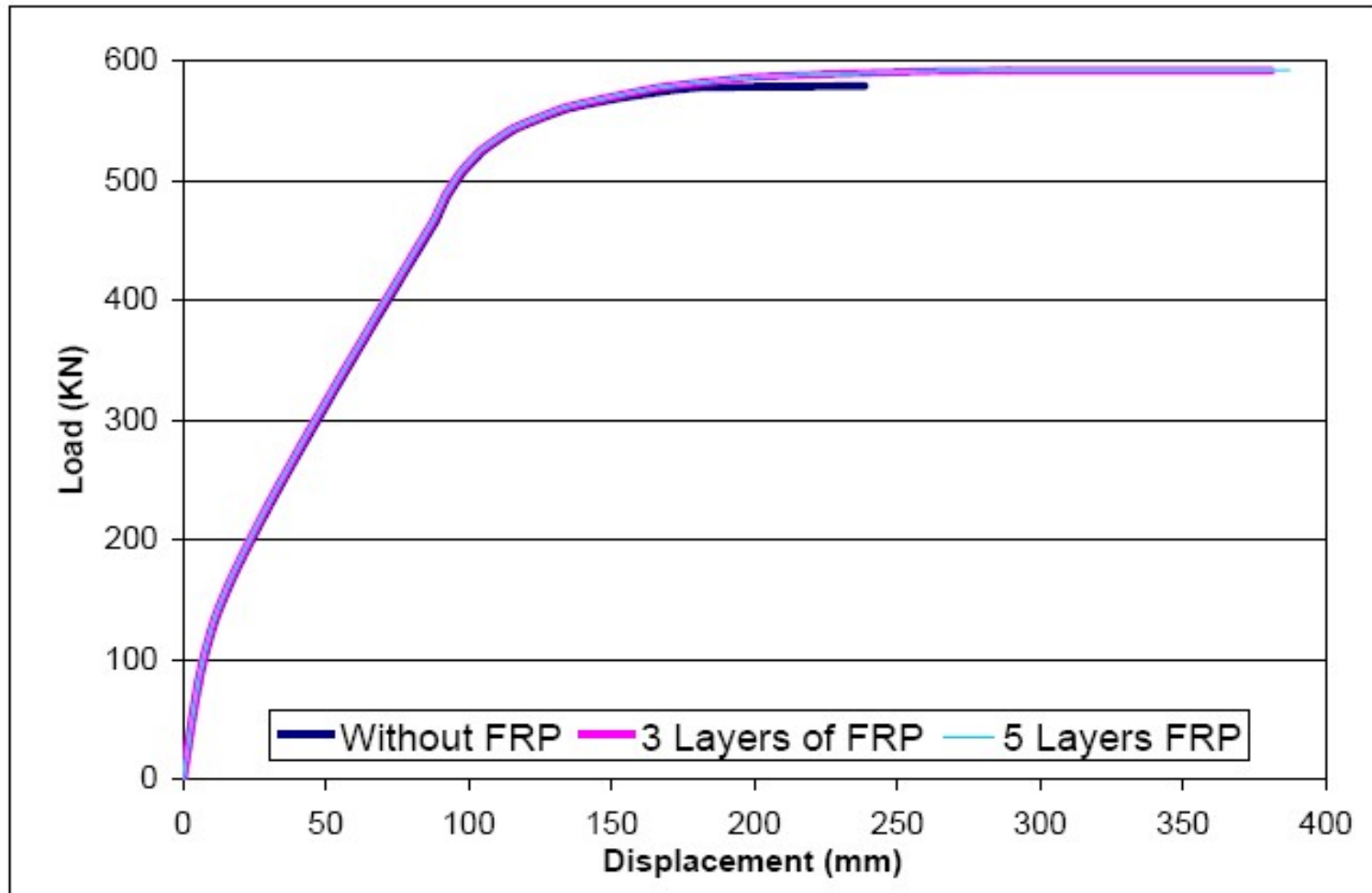

Column properties	
Concrete	20 Mpa
Side length	1400 mm
Corner rounding	50 mm

Wrap properties	
Thickness	0.36 & 0.6 (mm)
E-modulus (Mpa)	192500
Ultimate strain	0.005

Reinforcement	
Longitudinal	36 # 26
Transverse	4 # 14
Stirrup Spacing (hinge)	150 mm
Stirrup Spacing (rest)	200 mm
Steel Strength (MPa)	400

Past research projects at Empa

Prestressed confined concrete columns

PhD student Lars Janke

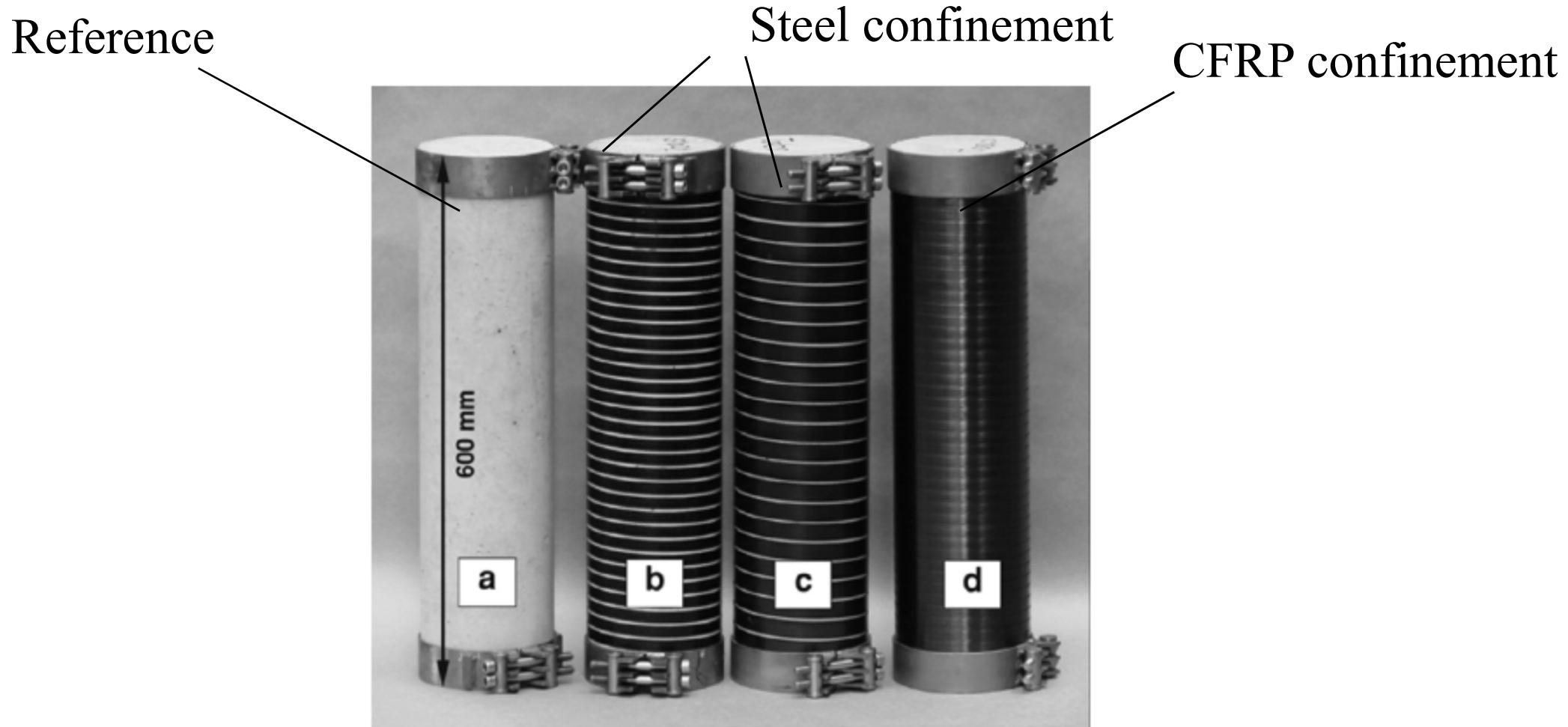

L. Janke, C. Czaderski, J. Ruth, M. Motavalli, Experiments on the residual load-bearing capacity of prestressed confined concrete columns, *Engineering Structures* 31 (2009) 2247-2256

Prestressed confined concrete columns

PhD student Lars Janke

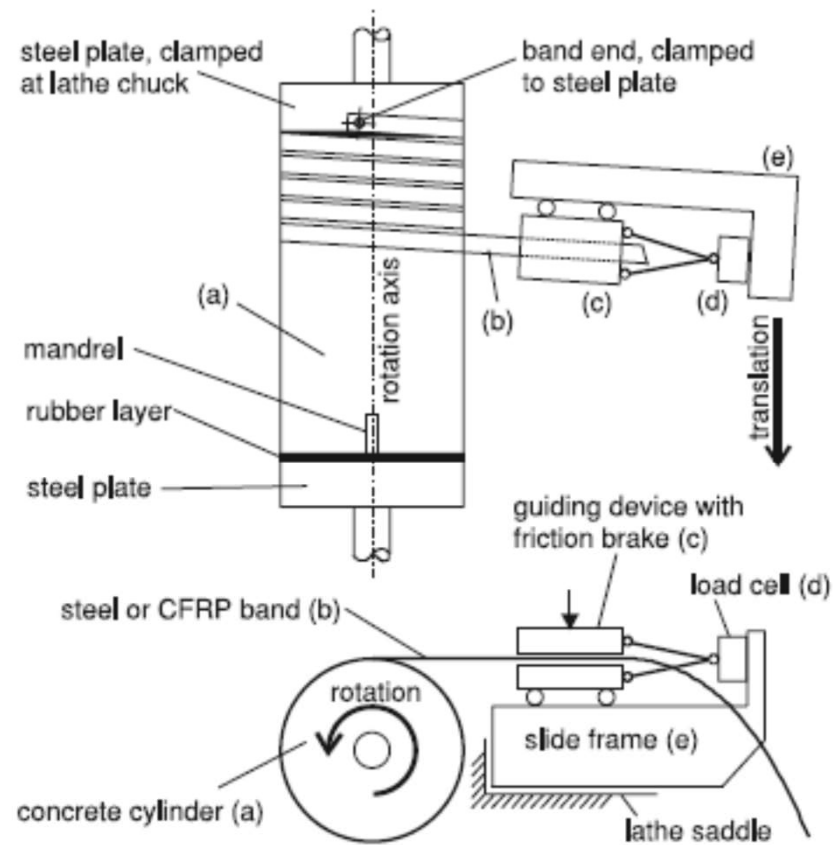

Fig. 4. Prestressing procedure.

L. Janke, C. Czaderski, J. Ruth, M. Motavalli, Experiments on the residual load-bearing capacity of prestressed confined concrete columns, Engineering Structures 31 (2009) 2247-2256

Prestressed confined concrete columns

PhD student Lars Janke

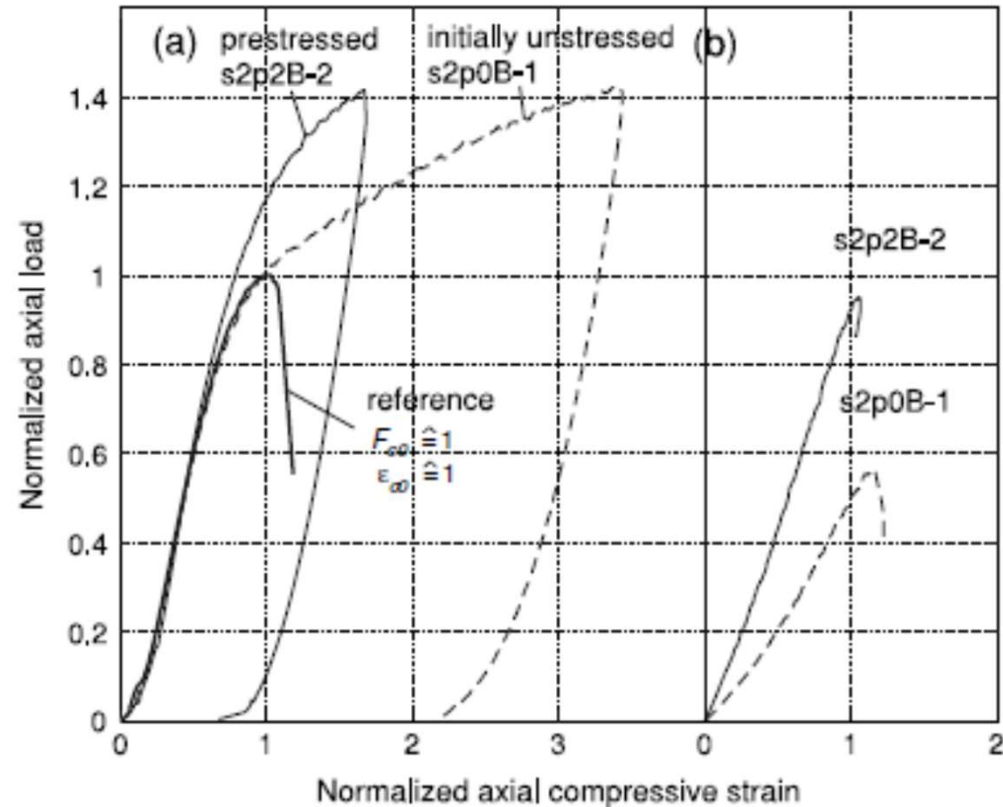

Fig. 7. Typical axial load-compressive strain curves of Series B: (a) load cycle to 140% of F_{c0} with confinement, (b) breaking test after removal of confinement.

L. Janke, C. Czaderski, J. Ruth, M. Motavalli, Experiments on the residual load-bearing capacity of prestressed confined concrete columns, Engineering Structures 31 (2009) 2247-2256

Carbon Fibre confinement of rectangular RC columns without bond:

CFRP straps:

- T 700 C-Fibres
- Matrix: PA 12 (Thermoplastic)
 - Only 0.1 mm thick
 - Can be welded

Confinement without bond



Externally Bonded FRP: Confinement

Fibre Composites, FS23

Masoud Motavalli

Confinement without bond

Column cross-section



Confinement without bond

Hose

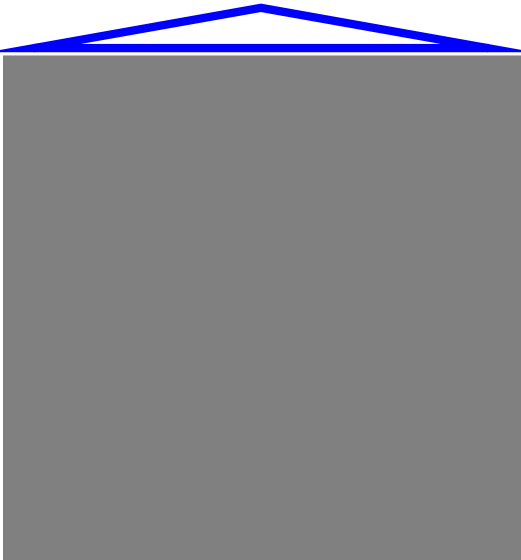

Externally Bonded FRP: Confinement

Fibre Composites, FS23

Masoud Motavalli

Confinement without bond

Hose

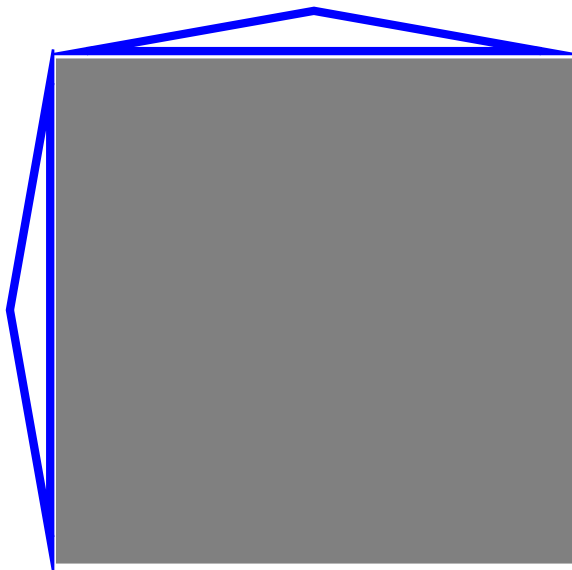

Confinement without bond

Hose

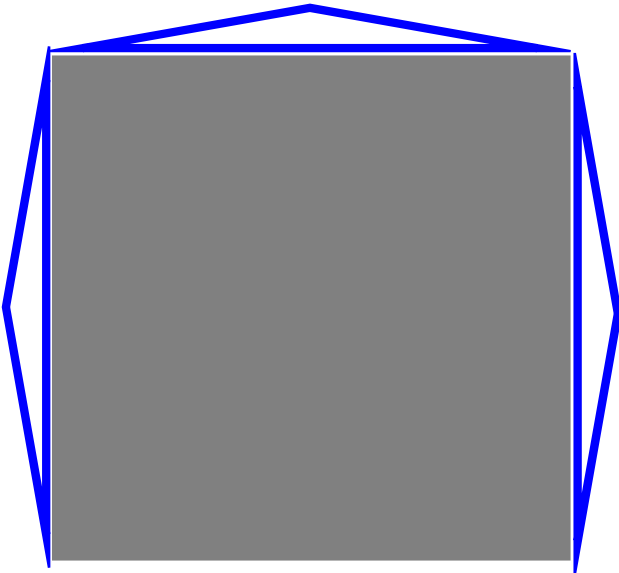

Externally Bonded FRP: Confinement

Fibre Composites, FS23

Masoud Motavalli

Confinement without bond

Hose

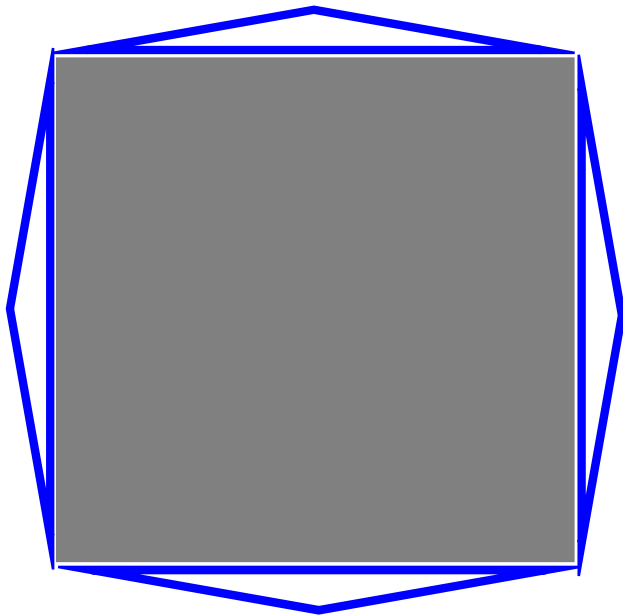

Confinement without bond

Wrapping of 0.1 mm thick straps

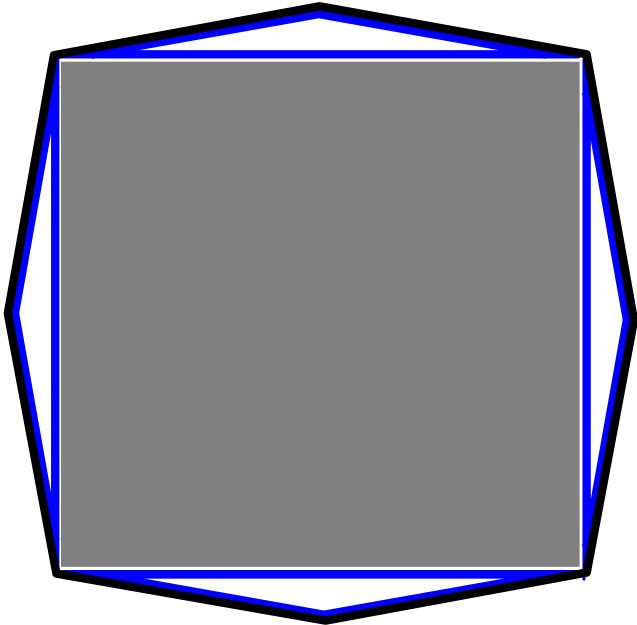

Confinement without bond

Injection of polymer mortar with pressure

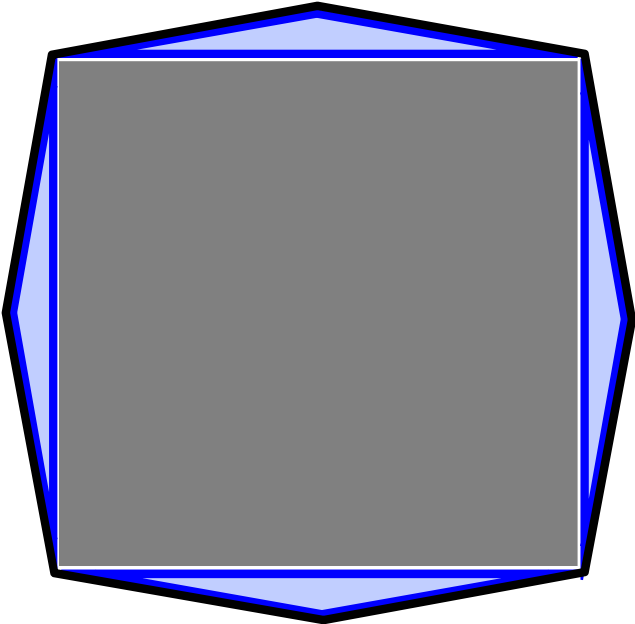

Externally Bonded FRP: Confinement

Fibre Composites, FS23

Masoud Motavalli

Confinement without bond

Injection of polymer mortar
With pressure

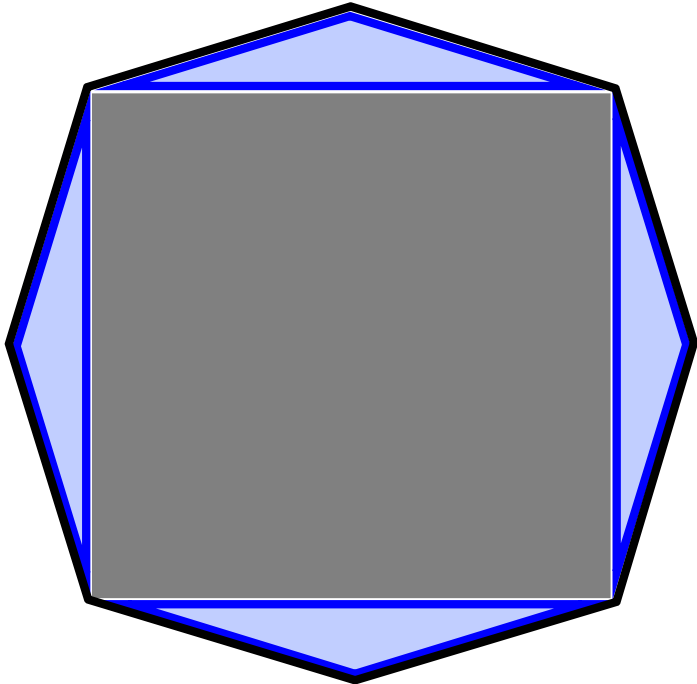

Externally Bonded FRP: Confinement

Fibre Composites, FS23

Masoud Motavalli

Confinement without bond

Injection of polymer mortar
With pressure

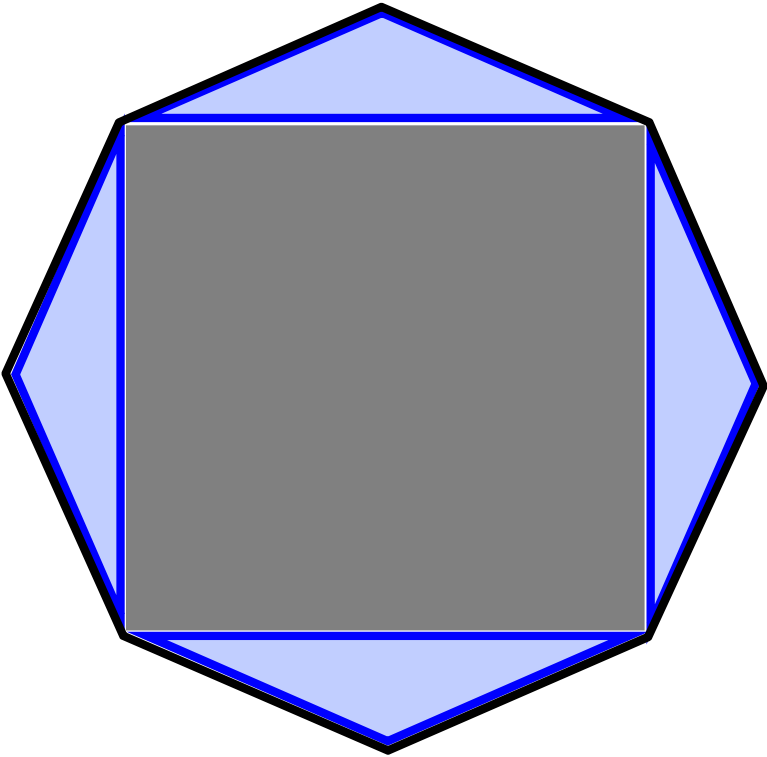

Externally Bonded FRP: Confinement

Fibre Composites, FS23

Masoud Motavalli

Confinement without bond

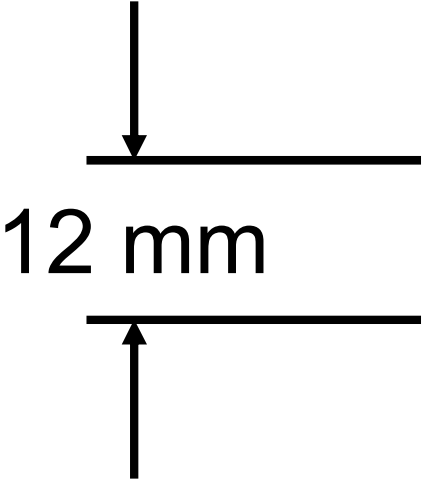

min. radius = 10 mm

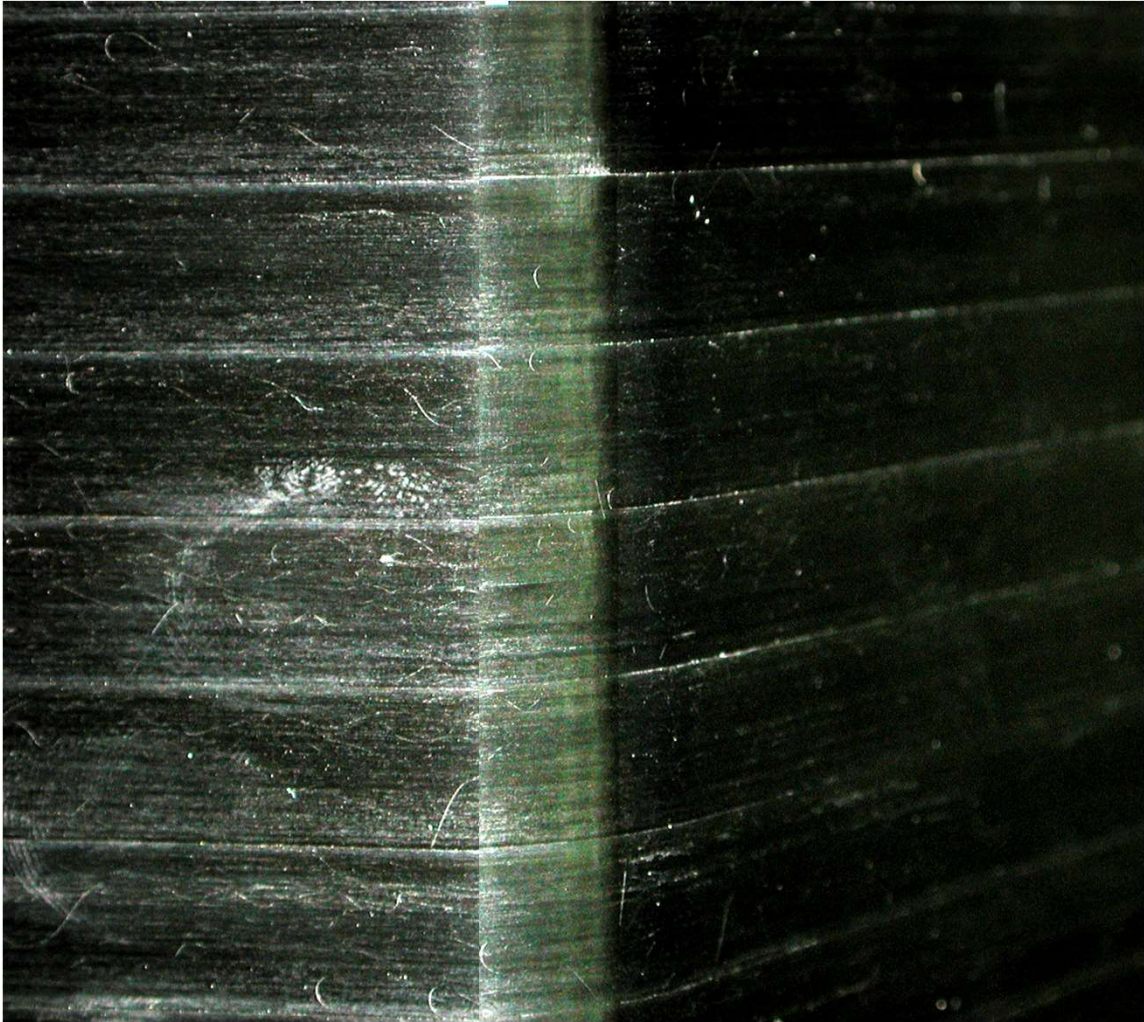

Axial compression test

Confined column (6 layers FRP, prestressed by 2 hoses at each column side)

Maximum Load: 3713 kN

Maximum displacement: -63.8 mm (at failure)

Maximum average reinforcement strain: $-2500 \mu\epsilon$

Maximum average FRP strain: $-8063 \mu\epsilon + 2300 \mu\epsilon = 10363 \mu\epsilon$

Cylinder strength of concrete after 28 days: 19.5MPa, Test was after 35 days (waiting for additional data)

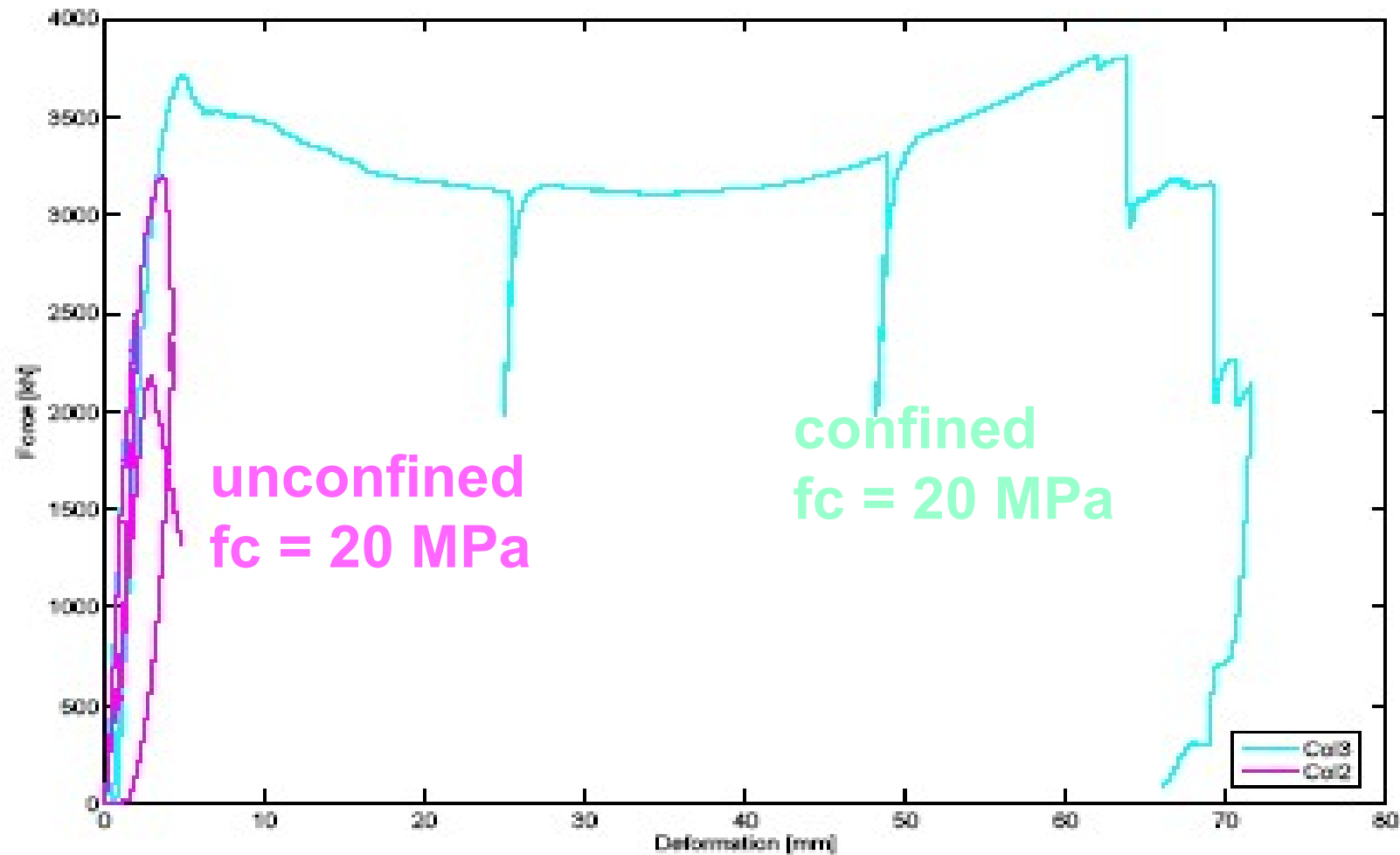
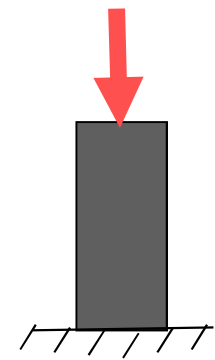



Externally Bonded FRP: Confinement

Fibre Composites, FS23

Masoud Motavalli

< List of Symbols >

< Column Confinement >

ϵ_{ju}	: Jacket ultimate circumferential strain
σ_e	: Lateral confining pressure
ρ_j	: volumetric ratio of FRP jacket (or ρ_f)
σ_j	: stress in FRP jacket
E_j	: FRP E-modulus in fibre direction
t_j	: jacket thickness (t_f or t_{FRP})
d_j	: diameter of the jacket
f_e	: maximum lateral confining pressure (or f_{2FRP})
f_j	: FRP jacket strength
f_c	: confined concrete peak strength (or f'_c)
f_{c0}	: unconfined concrete strength (or f'_c)
λ_a	: confinement effectiveness coefficient
ρ_s	: longitudinal steel reinforcement ratio
r	: cross-section corner radius
n	: number of FRP layers (or N_b)
D_g	: column diameter
μ_D	: Deformation ductility factor